

COMPONENTS

MODULES

ROBOTICS

SYSTEMS

Linear Technology

Linearführungen

Racks and pinions: 04: Pinions, Worm Wheel Sets

Zahnstangen und Ritzel: 04: Stirnräder und Schneckradsätze

Bevel gears

Kegelräder

Worm gear units

Schneckengetriebe

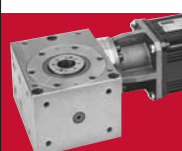
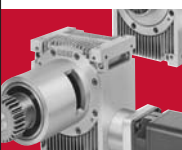
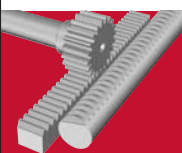
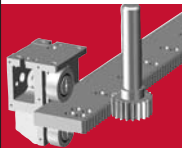
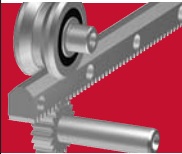

Die Angaben in diesem Katalog wurden mit äusserster Sorgfalt erarbeitet und geprüft. Trotzdem kann für fehlerhafte oder unvollständige Angaben keine Haftung übernommen werden. Nachdruck, auch auszugsweise, ist nur mit unserer Genehmigung gestattet. Änderungen im Sinne technischer Verbesserungen bleiben vorbehalten.

Ce catalogue a été soigneusement composé et toutes ses données vérifiées. Toutefois, nous déclinons toute responsabilité en cas d'erreurs ou d'omissions. Par suite du développement constant de nos recherches, nous devons nous réserver tout droit de modifications de produits de notre fabrication.

This catalogue has been produced with a great deal of care and attention. All data has been checked for accuracy. However, no liability can be accepted for any incorrect or incomplete data. All rights reserved. Reproduction in whole or in part without our authorisation is prohibited.

GÜDEL AG

Industrie Nord
CH-4900 Langenthal
Switzerland
phone +41 62 916 91 91
fax +41 62 916 91 50
eMail info@ch.gudel.com
www.gudel.com

GÜDEL GmbH

Carl-Benz-Strasse 5
D-63674 Albstadt
Germany
phone +49 6047 9639 0
fax +49 6047 9639 90
eMail info@de.gudel.com
www.gudel.com

GÜDEL Inc.

4881 Runway Blvd.
US-Ann Arbor, MI 48108
USA
phone +1 734 214 0000
fax +1 734 214 9000
eMail info@us.gudel.com
www.gudel.com

ALL LOCAL REPRESENTATIONS SEE:

WWW.GUDEL.COM/GOLOCAL

Einführung

Der vorliegende Katalog umfasst die Komponenten der Linear- und Antriebstechnik. Der Inhalt widerspiegelt die Erfahrung von mehr als 5 Jahrzehnten der Entwicklung und Fertigung von Längsführungen, Verzahnungen und Getriebebau.

Das nach ISO 9001: 2000 aufgebaute Qualitätssystem, eine grosse Lagerhaltung und ein weltweites Vertriebsnetz garantieren einen optimalen Kundennutzen.

Das umfangreiche Standardprogramm ermöglicht einen schnellen Zugriff auf alle Komponenten.

Ein erfahrenes Ingenieurteam hilft Ihnen bei der Auswahl, erarbeitet mit Ihnen Einbauvorschläge und optimiert Ihren Anwendungsfall. Auch Sonderteile nach Ihren Zeichnungen stellen wir gerne für Sie her.

Sprechen Sie mit uns!

Introduction

Le catalogue suivant comprend les composants de la technique linéaire et d'entraînement. Le contenu reflète l'expérience de plus de 5 décennies de développement et de fabrication de guides longitudinaux, de dentures et de construction d'engrenages.

Le système de qualité élaboré selon ISO 9001: 2000, un stock important et un réseau de distribution mondial garantissent au client un profit optimal.

La riche gamme standard permet un accès rapide à tous les composants.

Une équipe d'ingénieurs expérimentés vous aidera à choisir, travaillera avec vous des projets de montage et optimisera votre cas d'application. Nous fabriquerons également des pièces spéciales pour vous selon vos dessins. Parlez-nous de vos applications!

Introduction

This catalogue covers all the components of the linear and drive technology. Its content reflects the experience of more than 5 decades in the development and manufacture of linear guides, gears and gearboxes.

A quality system based on ISO 9001: 2000, a large inventory and a global distribution network guarantee optimal benefits to the customer.

The extensive standard programme makes rapid access to all components possible at all times.

An experienced engineering team will help you in your selection, and assist you in drawing up installation proposals and in the optimisation of your application. We will also be pleased to manufacture custom components to your own drawings. Call us!

Qualitätskontrolle

Um die hohen Qualitätsanforderungen unserer Kundschaft zu erfüllen, werden die Module auf modernsten Werkzeugmaschinen in eigenen Werken gefertigt. Die Qualitätskontrolle geschieht gemäss ISO 9001 als Erststück- und Stichprobenkontrolle.

Dies garantiert unserer Kundschaft den Erwerb eines qualitativ hochwertigen Produktes.

Production et qualité

Pour satisfaire les exigences de notre clientèle, les modules sont fabriqués dans nos propres usines par des machines modernes.

Le contrôle de qualité est fait suivant les exigences de la norme ISO 9001.

Tous ces efforts garantissent à notre clientèle un produit de haute qualité.

Quality control

To meet the high requirements of our clients, the modules are manufactured in our factories by modern machine tools. Quality control is carried out in accordance with ISO 9001.

This guarantees our clients a continuous high product quality.

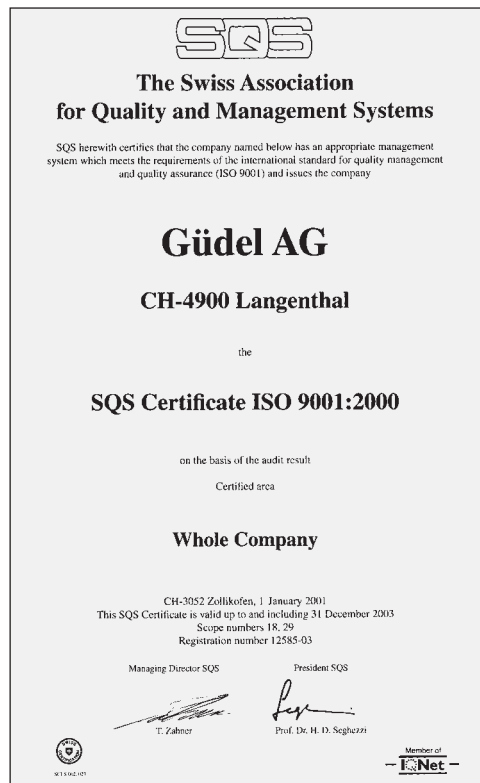

Stirnräder und Schneckenradsätze

Unser Standardprogramm von Stirnrädern beinhaltet eine Vielzahl an Ausführungsvarianten in unterschiedlichen Qualitäten und Werkstoffen wie Stahl, korrosionsbeständiger Stahl und Kunststoff.

Unser Standardprogramm von Schneckenradsätzen umfasst 7 Baugrößen. Jede Baugröße enthält 8 Übersetzungen. Der Konstrukteur kann zwischen Schafschnecken und Bohrungsschnecken wählen. Das Programm ist uneingeschränkt austauschbar.

Sonderanfertigungen stellen wir gerne nach Ihren Zeichnungen als Einzelstück oder Serie her.

Unsere Ingenieure, denen entsprechende Rechnungsprogramme zur Verfügung stehen, helfen Ihnen gerne Ihren Anwendungsfall zu optimieren.

Roues dentées, couple à roue sans fin Pinions, worm wheel sets

Notre programme de roues dentées contient une large gamme d'exécution de différentes qualités différentes matières comme l'acier, l'acier inox ou le plastique.

Notre gamme des vis sans fin et roues à vis sans fin contient 7 tailles. Chaque taille est exécutée avec 8 rapports. Notre large gamme nous permet de vous proposer le composant adapté à vos applications.

Nous pouvons également réaliser des pièces spécifiques selon plan.

De plus nos ingénieurs, à l'aide de programmes de calcul sont à votre disposition afin d'optimiser vos applications.

Our standard range of pinions contain a large variety of executions in different qualities and materials such as steel, stainless steel and plastic.

Our standard range of worm and worm gears contains 7 sizes. Each size is available in 8 ratios. You may select between hollow worms and worms with shaft. The range is interchangeable without restriction.

















We are also able to produce special products to your designs.

Our engineers are equipped with calculation programs and will be glad to help you to find the right product for your application.



INHALTSVERZEICHNIS

TABLE DES MATIÈRES / CONTENT

Reihe Series	Module Module	Wärmebehandlung der Verzähg. Traitement du dent Heat-treatment of teeth	Bearbeitung	Verzähngstoleranz Tolerance du dent Tolerance of teeth	Seite Page
 SN	gerade droite straight 1.0, 1.5, 2.0, 2.5, 3.0, 4.0, 5.0, 6.0, 8.0	Stahl acier steel	feinstverzähnt taillage de précision precision cut	8e25	04.04
 SNB	gerade droite straight 1.0, 1.5, 2.0, 2.5, 3.0, 4.0, 5.0, 6.0, 8.0	Stahl acier steel	feinstverzähnt taillage de précision precision cut	8e25	04.04
 ST	gerade droite straight 1.0, 1.5, 2.0, 2.5, 3.0, 4.0, 5.0, 6.0, 8.0	Stahl acier steel	feinstverzähnt taillage de précision precision cut	8e25	04.04
 SNE	gerade droite straight 1.0, 1.5, 2.0, 2.5, 3.0, 4.0	rostfrei inox stainless	feinstverzähnt taillage de précision precision cut	8e25	04.13
 LM	gerade droite straight 1.0, 1.5, 2.0, 2.5, 3.0, 4.0, 5.0	gehärtet trempée hardened	feinstverzähnt taillage de précision precision cut	9e25	04.14
 LMV	gerade droite straight 2.5, 3.0, 4.0,	Stahlnabe-Kunststoff PA 12 G Moyeu en acier, Polyamide Steel hub, Polyamide PA 12 G	feinstverzähnt taillage de précision precision cut	8e25	04.15
 SH	gerade droite straight 0.5, 1.0, 1.25, 1.5, 2.0, 3.0	Kunststoff Hostaform C Polyamide Polyamide	gespritzt moulée par inject inject moulded	12	04.19
	Leistungstabelle Tableau des caractéristiques Selection table				04.26
	1.0	a = 30mm	Bronze Stahl Bronce Acier Bronce Steel	feinstverzähnt taillage de précision precision cut	8f24 04.28
	1.5	a = 45mm	Bronze Stahl Bronce Acier Bronce Steel	feinstverzähnt taillage de précision precision cut	8f24 04.29
	2.0	a = 60mm	Bronze Stahl Bronce Acier Bronce Steel	feinstverzähnt taillage de précision precision cut	8f24 04.30
	2.5	a = 75mm	Bronze Stahl Bronce Acier Bronce Steel	feinstverzähnt taillage de précision precision cut	8f24 04.31
	3.0	a = 90mm	Bronze Stahl Bronce Acier Bronce Steel	feinstverzähnt taillage de précision precision cut	8f24 04.32
	3.5	a = 105mm	Bronze Stahl Bronce Acier Bronce Steel	feinstverzähnt taillage de précision precision cut	8f24 04.33
	4.0	a = 120mm	Bronze Stahl Bronce Acier Bronce Steel	feinstverzähnt taillage de précision precision cut	8f24 04.34
	Einbau und Schmierung Montage et lubrification Assembly and Lubrication				04.35



PRODUKTÜBERSICHT

GAMME DES PRODUITS PRODUCT OVERVIEW

Elemente

SN / SNB / ST

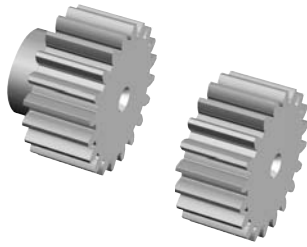

04.04-04.12

Eléments

Inox

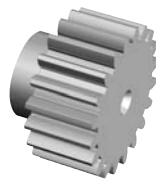

04.13

Elements

Gehärtet / trempée / hardened

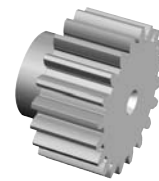

04.14

PA 12



04.17-04.18

Hostaform C



04.20-04.25



04.28-04.34



04.30-04.34

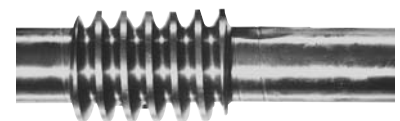

04.28-04.34

STIRNRÄDER

ROUES DENTÉES PINIONS

Wichtige Hinweise

Die angegebenen Drehmomente (Md) Werte basieren auf einer mittleren Drehzahl von 200 U/min bei

$s_F = 1.4$
(Sicherheitsfaktor Zahnfußbeanspruchung)

$s_H = 1.0$
(Sicherheitsfaktor Zahnflankenbeanspruchung)

Für höhere Leistungen empfehlen wir ein nachträgliches Nitrieren (Bad-, Gas-, Plasma-) mit Faktor 1.5 oder ein Induktivhärten der Zähne mit Faktor 2.5.

Für hohe Leistungen und Drehzahlen wird der Einsatz der gehärteten und ballig geschliffenen oder schälwälzgefrästen Zahnräder in Qualität 6 (ab Seite 03.08/03.13/03.27) empfohlen.

Für besondere Anwendungen mit hohen Notlaufeigenschaften und Geräuschdämpfung, grosser Verschleissfestigkeit und Dimensionsstabilität sind die LMV-PA12G Kunststoffzahnräder mit eingegossenen Stahlnaben geeignet (ab Seite 04.15).

Für einfache Antriebe genügen oft unsere aus dem Kunststoff Hostaform C gespritzten Zahnräder, wobei unsere Berechnungsgrundlagen Ihnen einen schnellen Hinweis auf die geeigneten Elemente geben.

Nacharbeiten nach Ihren Zeichnungen stellen für uns kein Problem dar, ebenso wie komplette Sonderanfertigungen in nahezu allen Werkstoffen in den Dimensionsbereichen unserer Standardelemente.

Die angegebenen Drehmomente (Md) beziehen sich auf eine Paarung von zwei Stirnrädern des jeweiligen Typs.

Informations importantes

Les valeurs de couple indiquées sont basées sur une valeur de 200tr/min avec:

$s_F = 1.4$
(Coefficient de sécurité pour la contrainte de flexion)

$s_H = 1.0$
(Coefficient de sécurité pour la pression superficielle) en fonctionnement continu

Pour des charges plus élevées nous recommandons de traiter les roues par trempage superficielle qui donne une élévation de couple de env. 2.5 ou par nitration qui donne une élévation de couple de env. 1.5.

Pour de hautes puissances et de hautes vitesses de rotation nous recommandons de travailler avec des pignons avec denture trempée et rectifiée bombée ou fraisée en qualité 6 (dès page 03.08/03.13/03.27).

Pour des applications spéciales avec pauvre lubrification, silencieux et grande stabilité des dimensions nous proposons des pignons en plastic type LMV-PA12G avec des moyeux moulés insolubles (dès page 04.15).

Pour des applications inférieures il suffit de choisir des pignons fait par injection en Hostaform C ou nos calculs vous aident de choisir très rationnel le pignon correspondant à votre utilisation.

Nous pouvons également réaliser des roues selon plan, et cela dans la plupart des matières selon les dimensions de nos éléments standard.

Les couples notées (Md) se rapportent à une combinaison de deux roues du type correspondant.

Important notes

The listed torques (Md) are based on a rotational speed of 200 rpm

$s_F = 1.4$
(Safety factor for tooth root stress)

$s_H = 1.0$
(Safety factor for Hertzian stress) for continuous operation

For higher performance we recommend nitriding (factor 1.5) or to harden (factor 2.5) the teeth.

For high performance and high torque applications we recommend you fit hardened and crowned pinions in tooth quality of 6 (page 03.08/03.13/03.27).

For special applications with poor lubrication, low noise, low wear and high dimensional stability we have plastic pinions and plastic pinions in LMV PA12G with a cast metal insert. (page 04.15).

For less accurate applications it might be suitable to choose moulded pinions made of Hostaform C where our calculation input helps to choose the correct elements.

We are able to offer our standard pinions machined to suit your requirements.

The mentioned torques (Md) refer to a combination of two pinions of the corresponding type.



STIRNRÄDER AUS STAHL

ROUES DENTÉES EN ACIER PINIONS STEEL

feinstverzahnt taillage de précision precision cut
Quality 8e25

Gerade verzahnt, feinstverzahnt

Dentures droites, taillage de précision

Straight tooth, precision cut

Material: ETG100 DIN 17210 $\varnothing < 63$ mm
Ck45 DIN 1.1191 $\varnothing > 63$ mm
Zahnung: Eingriffswinkel $\alpha = 20^\circ$
feinstverzahnt
Qualität: 8e25 DIN 3962/63/67

Matière: ETG100 DIN 17210 $\varnothing < 63$ mm
Ck45 DIN 1.1191 $\varnothing > 63$ mm
Denture: angle de pression $\alpha = 20^\circ$
taillage de précision
Qualité: 8e25 DIN 3962/63/67

Material: ETG100 DIN 17210 $\varnothing < 63$ mm
Ck45 DIN 1.1191 $\varnothing > 63$ mm
Teeth: pressure angle $\alpha = 20^\circ$
precision cut
Quality: 8e25 DIN 3962/63/67

Modul (mm)	Zähnezahl No. de dents No. of teeth		D ₀	D _k	N	Part No.	M _d (Nm)	Part No.	M _d (Nm)	Part No.	M _d (Nm)
	Z	BH7									
1.0		5	12	14	9	SNB 1012	0.2	SN 1012	0.15		
		5	13	15	10	SNB 1013	0.3				
		5	14	16	10	SNB 1014	0.3	SN 1014	0.22		
		6	15	17	12	SNB 1015	0.4	SN 1015	0.23		
		6	16	18	13	SNB 1016	0.5	SN 1016	0.25		
		6	17	19	14	SNB 1017	0.6				
		8	18	20	15	SNB 1018	0.7	SN 1018	0.36		
		8	19	21	16	SNB 1019	0.8				
		8	20	22	17	SNB 1020	0.9	SN 1020	0.46		
		8	21	23	18	SNB 1021	1.0	SN 1021	0.51		
		8	22	24	19	SNB 1022	1.1				
		8	23	25	20	SNB 1023	1.2				
	8	24	26	20	SNB 1024	1.3	SN 1024	0.68			
	8	25	27	22	SNB 1025	1.4	SN 1025	0.70			
	8	26	28	22	SNB 1026	1.5					
	8	27	29	23	SNB 1027	1.6					
	8	28	30	25	SNB 1028	1.7	SN 1028	0.90			
	8	29	31	25	SNB 1029	1.8					
	8	30	32	25	SNB 1030	1.9	SN 1030	1.00			
	10	31	33	25	SNB 1031	2.0					
	10	32	34	25	SNB 1032	2.1	SN 1032	1.10			
	10	33	35	25	SNB 1033	2.3					
	10	34	36	28	SNB 1034	2.4					
	10	35	37	28	SNB 1035	2.6	SN 1035	1.30			
	10	36	38	28	SNB 1036	2.7	SN 1036	1.40			
	10	37	39	28	SNB 1037	2.8					
	10	38	40	28	SNB 1038	3.0					
	10	39	41	28	SNB 1039	3.1					
	10	40	42	30	SNB 1040	3.3	SN 1040	1.70			
	10	41	43	30	SNB 1041	3.4					
	10	42	44	30	SNB 1042	3.6	SN 1042	1.90			
	10	43	45	30	SNB 1043	3.8					
	10	44	46	30	SNB 1044	3.9					
	10	45	47	30	SNB 1045	4.1	SN 1045	2.20			
	10	46	48	30	SNB 1046	4.3					
	10	47	49	35	SNB 1047	4.5					
	10	48	50	35	SNB 1048	4.6	SN 1048	2.40			
	10	49	51	35	SNB 1049	4.8					
	10	50	52	35	SNB 1050	5.0	SN 1050	2.70			
	10	51	53	35	SNB 1051	5.1					
	10	52	54	40	SNB 1052	5.2					
	10	53	55	40	SNB 1053	5.4					
	10	54	56	40	SNB 1054	5.6	SN 1054	3.00			
	10	55	57	40	SNB 1055	5.8					
	10	56	58	40	SNB 1056	6.0	SN 1056	3.20			
	10	57	59	40	SNB 1057	6.1					
	10	58	60	45	SNB 1058	6.3					
	10	59	61	45	SNB 1059	6.5					
	10	60	62	50	SNB 1060	6.7	SN 1060	3.60			
	10	64	66	50	SNB 1064	7.6					
	10	70	72	50			SN 1070	4.90			
	10	72	74	50	SNB 1072	9.7	SN 1072	5.10			
	10	75	77	50			SN 1075	5.50			
	10	80	82	50	SNB 1080	11.9				ST 1080	6.30
	12	90	92	50	SNB 1090	14.9				ST 1090	7.90
	12	96	98	50	SNB 1096	16.8				ST 1096	8.90
	12	100	102							ST 10100	9.70
	12	120	122							ST 10120	13.70

STIRNRÄDER AUS STAHL

feinstverzahnt
taillage de précision
precision cut
Quality
8e25

ROUES DENTÉES EN ACIER PINIONS STEEL

Gerade verzahnt, feinstverzahnt

Dentures droites, taillage de précision

Straight tooth, precision cut

Material: ETG100 DIN 17210 Ø<63 mm
Ck45 DIN 1.1191 Ø>63 mm
Zahnung: Eingriffswinkel $\alpha=20^\circ$
feinstverzahnt
Qualität: 8e25 DIN 3962/63/67

Matière: ETG100 DIN 17210 Ø<63 mm
Ck45 DIN 1.1191 Ø>63 mm
Denture: angle de pression $\alpha=20^\circ$
taillage de précision
Qualité: 8e25 DIN 3962/63/67

Material: ETG100 DIN 17210 Ø<63 mm
Ck45 DIN 1.1191 Ø>63 mm
Teeth: pressure angle $\alpha=20^\circ$
precision cut
Quality: 8e25 DIN 3962/63/67

Zähnezahl
No. de dents
No. of teeth

Modul (mm)

1.5

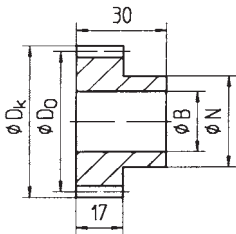

Typ SNB

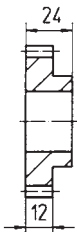

Typ SN

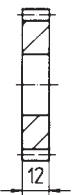

Typ ST

Z	BH7	Do	Dk	N	Part No.	Md (Nm)	① Part No.	Md (Nm)	① Part No.	① Md (Nm)
12	6	18	21	13	SNB 1512	0.8	SN 1512	0.5		
13	6	19.5	22.5	15	SNB 1513	0.9	SN 1513	0.6		
14	6	21	24	16	SNB 1514	1.1	SN 1514	0.7		
15	8	22.5	25.5	18	SNB 1515	1.2	SN 1515	0.9	ST 1515	0.9
16	8	24	27	19	SNB 1516	1.4	SN 1516	1.0	ST 1516	1.0
17	8	25.5	28.5	20	SNB 1517	1.7				
18	8	27	30	22	SNB 1518	1.9	SN 1518	1.3	ST 1518	1.3
19	8	28.5	31.5	22	SNB 1519	2.1				
20	8	30	33	25	SNB 1520	2.3	SN 1520	1.7	ST 1520	1.7
21	8	31.5	34.5	25	SNB 1521	2.5	SN 1521	1.8		
22	8	33	36	28	SNB 1522	2.8				
23	8	34.5	37.5	28	SNB 1523	3.0				
24	8	36	39	30	SNB 1524	3.4	SN 1524	2.4	ST 1524	2.4
25	10	37.5	40.5	30	SNB 1525	3.6	SN 1525	2.6		
26	10	39	42	30	SNB 1526	3.9	SN 1526	2.7		
27	10	40.5	43.5	35	SNB 1527	4.1				
28	10	42	45	35	SNB 1528	4.4	SN 1528	3.1		
29	10	43.5	46.5	35	SNB 1529	4.8				
30	10	45	48	35	SNB 1530	5.0	SN 1530	3.5		
31	10	46.5	49.5	40	SNB 1531	5.4				
32	10	48	51	40	SNB 1532	5.7	SN 1532	4.0		
33	10	49.5	52.5	40	SNB 1533	6.0				
34	10	51	54	40	SNB 1534	6.2				
35	10	52.5	55.5	40	SNB 1535	6.6	SN 1535	4.6		
36	12	54	57	45	SNB 1536	6.9	SN 1536	4.8	ST 1536	4.8
37	12	55.5	58.5	45	SNB 1537	7.3				
38	12	57	60	45	SNB 1538	7.6				
39	12	58.5	61.5	45	SNB 1539	8.0				
40	12	60	63	45	SNB 1540	8.4	SN 1540	5.8	ST 1540	5.8
41	12	61.5	64.5	50	SNB 1541	8.8				
42	12	63	66	50	SNB 1542	9.2	SN 1542	6.4		
43	12	64.5	67.5	50	SNB 1543	9.6				
44	12	66	69	50	SNB 1544	10.0				
45	12	67.5	70.5	50	SNB 1545	10.5	SN 1545	7.3		
46	12	69	72	55	SNB 1546	10.9				
47	12	70.5	73.5	55	SNB 1547	11.4				
48	12	72	75	55	SNB 1548	11.8	SN 1548	8.2		
49	12	73.5	76.5	55	SNB 1549	12.3				
50	12	75	78	55	SNB 1550	12.8	SN 1550	9.2		
54	12	81	84	60	SNB 1554	14.8	SN 1554	10.7		
56	12	84	87	60	SNB 1556	15.8	SN 1556	11.4	ST 1556	11.4
57	12	85.5	88.5	60	SNB 1557	16.4				
60	15	90	93	60	SNB 1560	18.0	SN 1560	13.1		
64	15	96	99	70	SNB 1564	20.3	SN 1564	14.8		
70	15	105	108	70	SNB 1570	24.1	SN 1570	17.5		
72	15	108	111	70	SNB 1572	25.4	SN 1572	18.5	ST 1572	18.5
75	15	112.5	115.5	70			SN 1575	20.0		
80	15	120	123	70	SNB 1580	31.1	SN 1580	22.7	ST 1580	22.7
84	20	126	129	70		33.3	SN 1584	24.2	ST 1584	24.2
96	20	144	147	70		43.1	SN 1596	31.1		
120	20	180	183	70		66.3	SN 15120	47.9		

① mit / avec / with $S_F = 1.4$

(Sicherheitsfaktor für Zahnfußbeanspruchung)
(Coefficient de sécurité pour la contrainte de flexion)
(Safety factor for tooth root stress)

① mit / avec / with $S_H = 1.0$

(Sicherheitsfaktor für Zahnflankenbeanspruchung)
(Coefficient de sécurité pour la pression superficielle)
(Safety factor for Hertzian stress)



STIRNRÄDER AUS STAHL

ROUES DENTÉES EN ACIER PINIONS STEEL

feinstverzahnt taillage de précision precision cut
Quality 8e25

Gerade verzahnt, feinstverzahnt

Dentures droites, taillage de précision

Straight tooth, precision cut

Material: ETG100 DIN 17210 $\varnothing < 63$ mm
Ck45 DIN 1.1191 $\varnothing > 63$ mm
Zahnung: Eingriffswinkel $\alpha = 20^\circ$
feinstverzahnt
Qualität: 8e25 DIN 3962/63/67

Matière: ETG100 DIN 17210 $\varnothing < 63$ mm
Ck45 DIN 1.1191 $\varnothing > 63$ mm
Denture: angle de pression $\alpha = 20^\circ$
taillage de précision
Qualité: 8e25 DIN 3962/63/67

Material: ETG100 DIN 17210 $\varnothing < 63$ mm
Ck45 DIN 1.1191 $\varnothing > 63$ mm
Teeth: pressure angle $\alpha = 20^\circ$
precision cut
Quality: 8e25 DIN 3962/63/67

Modul (mm)	Zähnezahl No. de dents No. of teeth		D ₀	D _k	N	Part No.	M _d (Nm)	Part No.	M _d (Nm)	Part No.	M _d (Nm)
	Z	BH7									
2.0	12	10	24	28	18	SNB 2012	1.7	SN 2012	1.3	ST 2012	1.3
	13	10	26	30	19	SNB 2013	1.9	SN 2013	1.5		
	14	12	28	32	20	SNB 2014	2.2	SN 2014	1.8		
	15	12	30	34	24	SNB 2015	2.6	SN 2015	2.1		
	16	12	32	36	25	SNB 2016	3.0	SN 2016	2.5	ST 2016	2.5
	17	12	34	38	25	SNB 2017	3.5				
	18	12	36	40	30	SNB 2018	4.0	SN 2018	3.2	ST 2018	3.2
	19	12	38	42	32	SNB 2019	4.4				
	20	15	40	44	33	SNB 2020	4.9	SN 2020	4.0		
	21	15	42	46	34	SNB 2021	5.5	SN 2021	4.5		
	22	15	44	48	35	SNB 2022	6.0				
	23	15	46	50	35	SNB 2023	6.6				
24	15	48	52	40	SNB 2024	7.2	SN 2024	5.8	ST 2024	5.8	
25	15	50	54	43	SNB 2025	7.8	SN 2025	6.3			
26	15	52	56	45	SNB 2026	8.1					
27	15	54	58	45	SNB 2027	8.7					
28	15	56	60	45	SNB 2028	9.3	SN 2028	7.5	ST 2028	7.5	
29	15	58	62	50	SNB 2029	10.0					
30	15	60	64	50	SNB 2030	10.6	SN 2030	8.6	ST 2030	8.6	
31	20	62	66	50	SNB 2031	11.3					
32	20	64	68	50	SNB 2032	12.0	SN 2032	9.6			
33	20	66	70	50	SNB 2033	12.7					
34	20	68	72	50	SNB 2034	13.4					
35	20	70	74	50	SNB 2035	14.1	SN 2035	11.4			
36	20	72	76	50	SNB 2036	14.9	SN 2036	12.0			
37	20	74	78	55	SNB 2037	15.6					
38	20	76	80	55	SNB 2038	16.5					
39	20	78	82	60	SNB 2039	17.3					
40	20	80	84	60	SNB 2040	18.1	SN 2040	14.6	ST 2040	14.6	
41	20	82	86	65	SNB 2041	19.0					
42	20	84	88	65	SNB 2042	19.8	SN 2042	16.0			
43	20	86	90	70	SNB 2043	20.7					
44	20	88	92	70	SNB 2044	21.6					
45	20	90	94	70	SNB 2045	22.6	SN 2045	18.3			
46	20	92	96	70	SNB 2046	23.5					
47	20	94	98	70	SNB 2047	24.5					
48	20	96	100	70	SNB 2048	25.5	SN 2048	20.6			
49	20	98	102	80	SNB 2049	26.6					
50	20	100	104	80	SNB 2050	27.6	SN 2050	22.2	ST 2050	22.2	
54	20	108	112	80	SNB 2054	31.9	SN 2054	25.7	ST 2054	25.7	
56	25	112	116	90	SNB 2056	34.2	SN 2056	27.6			
57	25	114	118	90	SNB 2057	35.4					
60	25	120	124	90	SNB 2060	39.0	SN 2060	31.5	ST 2060	31.5	
64	25	128	132	90	SNB 2064	43.1					
70	25	140	144	90			SN 2070	41.2			
72	25	144	148	100	SNB 2072	53.8	SN 2072	43.5	ST 2072	43.5	
80	30	160	164	100	SNB 2080	66.0			ST 2080	53.3	
84	30	168	172						ST 2084	58.3	
96	30	192	196						ST 2096	75.5	
108	30	216	220						ST 20108	95.0	
120	30	240	244						ST 20120	116.0	



STIRNRÄDER AUS STAHL

feinstverzahnt
taillage de précision
precision cut
Quality
8e25

ROUES DENTÉES EN ACIER PINIONS STEEL

Gerade verzahnt, feinstverzahnt

Dentures droites, taillage de précision

Straight tooth, precision cut

Material: ETG100 DIN 17210 Ø<63 mm
Ck45 DIN 1.1191 Ø>63 mm
Zahnung: Eingriffswinkel $\alpha=20^\circ$
feinstverzahnt
Qualität: 8e25 DIN 3962/63/67

Matière: ETG100 DIN 17210 Ø<63 mm
Ck45 DIN 1.1191 Ø>63 mm
Denture: angle de pression $\alpha=20^\circ$
taillage de précision
Qualité: 8e25 DIN 3962/63/67

Material: ETG100 DIN 17210 Ø<63 mm
Ck45 DIN 1.1191 Ø>63 mm
Teeth: pressure angle $\alpha=20^\circ$
precision cut
Quality: 8e25 DIN 3962/63/67

Zähnezahl
No. de dents
No. of teeth

Modul (mm)

2.5

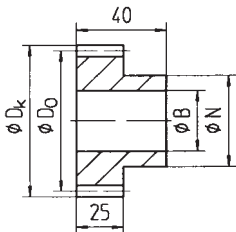

Typ SNB



Typ SN

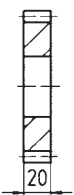

Typ ST

Modul (mm)	Z	BH7	D0	Dk	N	Part No.	Md (Nm)	Part No.	Md (Nm)	Part No.	Md (Nm)
12	10	30	35	23	SNB 2512	2.4	SN 2512	2.2			
13	10	32.5	37.5	24	SNB 2513	3.4					
14	15	35	40	28	SNB 2514	4.2	SN 2514	3.4			
15	15	37.5	42.5	30	SNB 2515	5.0	SN 2515	4.0			
16	15	40	45	30	SNB 2516	5.8	SN 2516	4.7			
17	15	42.5	47.5	30	SNB 2517	6.7					
18	15	45	50	35	SNB 2518	7.7	SN 2518	6.2			
19	15	47.5	52.5	35	SNB 2519	8.6					
20	15	50	55	40	SNB 2520	9.5	SN 2520	7.6			
21	15	52.5	57.5	45	SNB 2521	10.4	SN 2521	8.4			
22	15	55	60	45	SNB 2522	11.4					
23	15	57.5	62.5	45	SNB 2523	12.4					
24	15	60	65	50	SNB 2524	13.5	SN 2524	10.8			
25	15	62.5	67.5	55	SNB 2525	14.6	SN 2525	11.7			
26	15	65	70	55	SNB 2526	15.8					
27	15	67.5	72.5	60	SNB 2527	17.0					
28	15	70	75	60	SNB 2528	18.1	SN 2528	14.5			
29	15	72.5	77.5	60	SNB 2529	19.4					
30	15	75	80	65	SNB 2530	20.7	SN 2530	16.5	ST 2530	16.5	
31	20	77.5	82.5	65	SNB 2531	22.0					
32	20	80	85	70	SNB 2532	23.4	SN 2532	18.7			
33	20	82.5	87.5	70	SNB 2533	24.8					
34	20	85	90	70	SNB 2534	26.3					
35	20	87.5	92.5	70	SNB 2535	27.8	SN 2535	22.3			
36	20	90	95	70	SNB 2536	29.3	SN 2536	23.5	ST 2536	23.5	
37	20	92.5	97.5	75	SNB 2537	31.0					
38	20	95	100	75	SNB 2538	32.5					
39	20	97.5	102.5	80	SNB 2539	34.1					
40	20	100	105	80	SNB 2540	35.9	SN 2540	28.7			
42	20	105	110	80	SNB 2542	39.4	SN 2542	31.5	ST 2542	31.5	
45	20	112.5	117.5	90	SNB 2545	45.0	SN 2545	36.0			
48	20	120	125	90	SNB 2548	50.8	SN 2548	40.7			
50	20	125	130	100	SNB 2550	55.0	SN 2550	44.0	ST 2550	44.0	
54	25	135	140	100	SNB 2554	63.5	SN 2554	50.8			
56	25	140	145	100	SNB 2556	68.0	SN 2556	54.5			
60	25	150	155	100	SNB 2560	77.0	SN 2560	62.3			
70	25	175	180	100			SN 2570	83.7			
72	25	180	185	100	SNB 2572	110.2	SN 2572	88.3	ST 2572	88.3	
80	25	200	205	100			SN 2580	103.0	ST 2580	103.0	
84	30	210	215						ST 2584	119.0	
96	30	240	245						ST 2596	160.5	
108	30	270	275						ST 25108	202.0	
120	30	300	305						ST 25120	234.0	

① mit / avec / with $S_f = 1.4$

(Sicherheitsfaktor für Zahnfußbeanspruchung)
(Coefficient de sécurité pour la contrainte de flexion)
(Safety factor for tooth root stress)

① mit / avec / with $S_H = 1.0$

(Sicherheitsfaktor für Zahnflankenbeanspruchung)
(Coefficient de sécurité pour la pression superficielle)
(Safety factor for Hertzian stress)



STIRNRÄDER AUS STAHL

ROUES DENTÉES EN ACIER PINIONS STEEL

feinstverzahnt taillage de précision precision cut
Quality 8e25

Gerade verzahnt, feinstverzahnt

Material: Ck45 DIN 1.1191
Zahnung: Eingriffswinkel $\alpha=20^\circ$
feinstverzahnt
Qualität: 8e25 DIN 3962/63/67

Dentures droites, taillage de précision

Matière: Ck45 DIN 1.1191
Denture: angle de pression $\alpha=20^\circ$
taillage de précision
Qualité: 8e25 DIN 3962/63/67

Straight tooth, precision cut

Material: Ck45 DIN 1.1191
Teeth: pressure angle $\alpha=20^\circ$
precision cut
Quality: 8e25 DIN 3962/63/67

Modul (mm)	Zähnezahl No. de dents No. of teeth		D ₀	D _k	N	Part No.	M _d (Nm)	Part No.	M _d (Nm)	Part No.	M _d (Nm)
	Z	BH7									
3.0	12	15	36	42	25	SNB 3012	5.4	SN 3012	4.9		
	13	15	39	45	30	SNB 3013	6.3				
	14	15	42	48	30	SNB 3014	7.6	SN 3014	6.1		
	15	15	45	51	35	SNB 3015	9.1	SN 3015	7.3		
	16	15	48	54	35	SNB 3016	10.6	SN 3016	8.5		
	17	15	51	57	40	SNB 3017	12.3				
	18	15	54	60	45	SNB 3018	13.9	SN 3018	11.1		
	19	15	57	63	45	SNB 3019	15.0				
	20	15	60	66	45	SNB 3020	16.5	SN 3020	13.3		
	21	15	63	69	50	SNB 3021	18.2	SN 3021	14.5		
	22	15	66	72	50	SNB 3022	20.0				
	23	15	69	75	55	SNB 3023	21.7				
	24	15	72	78	55	SNB 3024	23.6	SN 3024	18.9		
	25	15	75	81	60	SNB 3025	25.5	SN 3025	20.4		
	26	15	78	84	65	SNB 3026	28.5				
	27	15	81	87	65	SNB 3027	30.7				
	28	15	84	90	70	SNB 3028	33.0	SN 3028	26.4	ST 3028	26.4
	29	15	87	93	70	SNB 3029	35.3				
	30	20	90	96	75	SNB 3030	37.6	SN 3030	30.1		
	31	20	93	99	80	SNB 3031	40.1				
	32	20	96	102	80	SNB 3032	42.6	SN 3032	34.1	ST 3032	34.1
	33	20	99	105	80	SNB 3033	45.2				
	34	20	102	108	85	SNB 3034	47.8				
	35	20	105	111	85	SNB 3035	50.6	SN 3035	40.5		
	36	20	108	114	90	SNB 3036	53.4	SN 3036	42.8		
	37	20	111	117	90	SNB 3037	56.3				
	38	20	114	120	95	SNB 3038	59.3				
	39	20	117	123	100	SNB 3039	62.3				
	40	20	120	126	100	SNB 3040	65.4	SN 3040	52.4	ST 3040	52.4
	42	20	126	132	100	SNB 3042	71.7	SN 3042	57.4	ST 3042	57.4
	45	20	135	141	100	SNB 3045	81.9	SN 3045	65.5		
	48	20	144	150	100	SNB 3048	93.0	SN 3048	74.2	ST 3048	74.2
	50	25	150	156	110	SNB 3050	100.4	SN 3050	80.3		
	54	25	162	168	110	SNB 3054	116.5	SN 3054	93.2		
	56	25	168	174	120	SNB 3056	125.0	SN 3056	100.0		
	60	25	180	186	120	SNB 3060	143.0	SN 3060	114.4	ST 3060	114.4
70	25	210	216	120			SN 3070	154.4			
72	25	216	222	120	SNB 3072	203.8	SN 3072	163.1	ST 3072	163.1	
80	30	240	246	120	SNB 3080	250.4			ST 3080	200.4	
96	30	288	294						ST 3096	273.5	

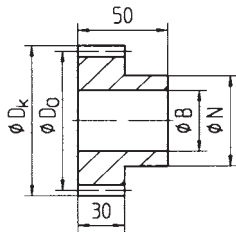

Typ SNB

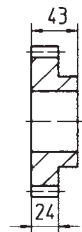

Typ SN

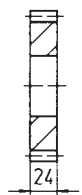

Typ ST

① mit / avec / with SF = 1.4

(Sicherheitsfaktor für Zahnfußbeanspruchung)
(Coefficient de sécurité pour la contrainte de flexion)
(Safety factor for tooth root stress)

① mit / avec / with SH = 1.0

(Sicherheitsfaktor für Zahnflankenbeanspruchung)
(Coefficient de sécurité pour la pression superficielle)
(Safety factor for Hertzian stress)



STIRNRÄDER AUS STAHL

feinstverzahnt
taillage de précision
precision cut
Quality
8e25

ROUES DENTÉES EN ACIER PINIONS STEEL

Gerade verzahnt, feinstverzahnt

Material: Ck45 DIN 1.1191
Zahnung: Eingriffswinkel $\alpha=20^\circ$
feinstverzahnt
Qualität: 8e25 DIN 3962/63/67

Dentures droites, taillage de précision

Matière: Ck45 DIN 1.1191
Denture: angle de pression $\alpha=20^\circ$
taillage de précision
Qualité: 8e25 DIN 3962/63/67

Straight tooth, precision cut

Material: Ck45 DIN 1.1191
Teeth: pressure angle $\alpha=20^\circ$
precision cut
Quality: 8e25 DIN 3962/63/67

Modul (mm)	Zähnezahl No. de dents No. of teeth		D _o	D _k	N	Part No.	M _d (Nm)	Part No.	M _d (Nm)	Part No.	M _d (Nm)
	Z	BH7									
4.0	12	20	48	56	35	SNB 4012	12.3	SN 4012	12.2		
	13	20	52	60	35	SNB 4013	15.2				
	14	20	56	64	45	SNB 4014	18.2	SN 4014	14.5		
	15	20	60	68	45	SNB 4015	21.2	SN 4015	16.8		
	16	20	64	72	50	SNB 4016	24.2	SN 4016	19.2		
	17	20	68	76	50	SNB 4017	27.4				
	18	20	72	80	55	SNB 4018	30.7	SN 4018	24.6		
	19	20	76	84	60	SNB 4019	34.2				
	20	20	80	88	65	SNB 4020	37.8	SN 4020	30.2		
	21	20	84	92	70	SNB 4021	41.6	SN 4021	33.2		
	22	20	88	96	70	SNB 4022	45.5				
	23	20	92	100	75	SNB 4023	49.5				
	24	20	96	104	75	SNB 4024	53.7	SN 4024	42.8		
	25	20	100	108	75	SNB 4025	58.1	SN 4025	46.2		
	26	20	104	112	80	SNB 4026	62.5				
	27	20	108	116	80	SNB 4027	67.3				
	28	20	112	120	80	SNB 4028	72.1	SN 4028	56.3		
	29	20	116	124	80	SNB 4029	77.0				
	30	20	120	128	80	SNB 4030	82.1	SN 4030	65.8		
	32	20	128	136	90	SNB 4032	93.1	SN 4032	74.3		
	35	30	140	148	90	SNB 4035	111.7	SN 4035	88.7		
	36	30	144	152	90	SNB 4036	118.2	SN 4036	93.8		
	40	30	160	168	100	SNB 4040	146.2	SN 4040	115.4	ST 4040	115.4
	42	30	168	176	100	SNB 4042	161.2	SN 4042	127.0		
	45	30	180	188	110	SNB 4045	185.2	SN 4045	145.2		
	48	30	192	200	110	SNB 4048	210.7	SN 4048	164.5	ST 4048	164.5
	50	30	200	208	120	SNB 4050	228.8	SN 4050	178.0		
	54	30	216	224	120	SNB 4054	264.8	SN 4054	210.4		
56	30	224	232	130	SNB 4056	287.2	SN 4056	225.4			
60	30	240	248	140	SNB 4060	327.2	SN 4060	264.7	ST 4060	264.7	
64	40	256	264	140	SNB 4064	369.5	SN 4064	299.0			
70	40	280	288	140			SN 4070	358.5			
72	40	288	296	140	SNB 4072	463.8	SN 4072	376.2	ST 4072	376.2	
80	40	320	328	140	SNB 4080	570.5		457.7	ST 4080	457.7	

① mit / avec / with S_F = 1.4

(Sicherheitsfaktor für Zahnfußbeanspruchung)
(Coefficient de sécurité pour la contrainte de flexion)
(Safety factor for tooth root stress)

① mit / avec / with S_H = 1.0

(Sicherheitsfaktor für Zahnflankenbeanspruchung)
(Coefficient de sécurité pour la pression superficielle)
(Safety factor for Hertzian stress)



STIRNRÄDER AUS STAHL

ROUES DENTÉES EN ACIER PINIONS STEEL

feinstverzahnt taillage de précision precision cut
Quality 8e25

Gerade verzahnt, feinstverzahnt

Dentures droites, taillage de précision

Straight tooth, precision cut

Material: Ck45 DIN 1.1191
Zahnung: Eingriffswinkel $\alpha=20^\circ$
feinstverzahnt
Qualität: 8e25 DIN 3962/63/67

Matière: Ck45 DIN 1.1191
Denture: angle de pression $\alpha=20^\circ$
taillage de précision
Qualité: 8e25 DIN 3962/63/67

Material: Ck45 DIN 1.1191
Teeth: pressure angle $\alpha=20^\circ$
precision cut
Quality: 8e25 DIN 3962/63/67

Modul (mm)	Zähnezahl No. de dents No. of teeth		D ₀	D _k	N	Part No.	M _d (Nm)	Part No.	M _d (Nm)	Part No.	M _d (Nm)
	Z	BH7									
5.0	12	20	60	70	45	SNB 5012	24.3	SN 5012	18.1		
	13	20	65	75	45	SNB 5013	30.7				
	14	20	70	80	55	SNB 5014	36.7	SN 5014	29.5		
	15	20	75	85	60	SNB 5015	42.4	SN 5015	34.2	ST 5015	34.2
	16	20	80	90	65	SNB 5016	48.4	SN 5016	39.1		
	17	20	85	95	70	SNB 5017	53.1				
	18	20	90	100	70	SNB 5018	61.8	SN 5018	49.3		
	19	20	95	105	70	SNB 5019	68.7				
	20	25	100	110	75	SNB 5020	75.8	SN 5020	60.5		
	21	25	105	115	75	SNB 5021	83.2				
22	25	110	120	80	SNB 5022	90.9					
23	25	115	125	80	SNB 5023	98.8					
24	25	120	130	80	SNB 5024	107.0	SN 5024	86.4			
25	25	125	135	80	SNB 5025	115.6	SN 5025	93.3			
26	25	130	140	90	SNB 5026	124.2					
27	25	135	145	90	SNB 5027	133.2					
28	25	140	150	90	SNB 5028	142.5	SN 5028	115.2			
29	25	145	155	90	SNB 5029	152.1					
30	25	150	160	90	SNB 5030	162.0	SN 5030	131.0	ST 5030	131	
32	30	160	170	100	SNB 5032	186.6	SN 5032	148.0			
35	30	175	185	100	SNB 5035	222.4	SN 5035	176.2			
36	30	180	190	105	SNB 5036	235.0	SN 5036	193.7			
38	30	190	200	105	SNB 5038	260.9					
40	30	200	210	110	SNB 5040	300.2	SN 5040	240.0	ST 5040	240	
45	30	225	235	110	SNB 5045	381.0	SN 5045	304.5			
48	30	240	250	120	SNB 5048	434.0	SN 5048	344.7	ST 5048	344.7	
50	30	250	260	120	SNB 5050	456.8	SN 5050	373.0			
54	30	270	280	130	SNB 5054	551.6	SN 5054	432.5			
56	30	280	290	140			SN 5056	463.6			
60	30	300	310	140	SNB 5060	678.4	SN 5060	526.4	ST 5060	526.4	
80	30	400	410						ST 5080	972.3	
90	30	450	460						● ST 5090	1260.8	
100	40	500	510						● ST 50100	1703.0	

- Auf Anfrage
- Sur demande
- On request

① mit / avec / with SF = 1.4

(Sicherheitsfaktor für Zahnfußbeanspruchung)
(Coefficient de sécurité pour la contrainte de flexion)
(Safety factor for tooth root stress)

① mit / avec / with SH = 1.0

(Sicherheitsfaktor für Zahnflankenbeanspruchung)
(Coefficient de sécurité pour la pression superficielle)
(Safety factor for Hertzian stress)



Seite / Page
03.11-03.23

STIRNRÄDER AUS STAHL

ROUES DENTÉES EN ACIER PINIONS STEEL

feinstverzahnt taillage de précision precision cut
Quality 8e25

Gerade verzahnt, feinstverzahnt

Material: Ck45 DIN 1.1191
Zahnung: Eingriffswinkel $\alpha=20^\circ$
feinstverzahnt
Qualität: 8e25 DIN 3962/63/67

Dentures droites, taillage de précision

Matière: Ck45 DIN 1.1191
Denture: angle de pression $\alpha=20^\circ$
taillage de précision
Qualité: 8e25 DIN 3962/63/67

Straight tooth, precision cut

Material: Ck45 DIN 1.1191
Teeth: pressure angle $\alpha=20^\circ$
precision cut
Quality: 8e25 DIN 3962/63/67

Modul (mm)	Zähnezahl No. de dents No. of teeth		D _o	D _k	N	Part No.	M _d (Nm) ^①
	Z	BH7					
6.0	12	20	72	84	50	SN 6012	52.3
	15	20	90	102	65	SN 6015	62.8
	16	20	96	108	70	SN 6016	71.7
	18	20	108	120	75	SN 6018	90.7
	20	25	120	132	80	SN 6020	111.2
	24	25	144	156	80	SN 6024	156.8
	25	25	150	162	90	SN 6025	169.2
	28	25	168	180	90	SN 6028	209.0
	30	25	180	192	100	SN 6030	247.4
	36	30	216	228	110	SN 6036	360.3
	40	30	240	252	120	SN 6040	446.7
	45	30	270	282	130	SN 6045	567.4
48	30	288	300	140	● SN 6048	644.2	
50	30	300	312	150	● SN 6050	701.5	

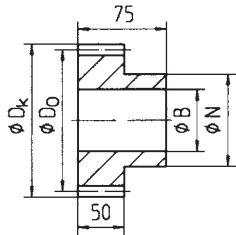

Typ SN

- Auf Anfrage
- Sur demande
- On request

① mit / avec / with $S_f = 1,4$

(Sicherheitsfaktor für Zahnfußbeanspruchung)
(Coefficient de sécurité pour la contrainte de flexion)
(Safety factor for tooth root stress)

① mit / avec / with $S_H = 1,0$

(Sicherheitsfaktor für Zahnflankenbeanspruchung)
(Coefficient de sécurité pour la pression superficielle)
(Safety factor for Hertzian stress)



STIRNRÄDER AUS STAHL

ROUES DENTÉES EN ACIER PINIONS STEEL

feinstverzahnt taillage de précision precision cut
Quality 8e25

Gerade verzahnt, feinstverzahnt

Material: Ck45 DIN 1.1191
Zahnung: Eingriffswinkel $\alpha=20^\circ$
feinstverzahnt
Qualität: 8e25 DIN 3962/63/67

Dentures droites, taillage de précision

Matière: Ck45 DIN 1.1191
Denture: angle de pression $\alpha=20^\circ$
taillage de précision
Qualité: 8e25 DIN 3962/63/67

Straight tooth, precision cut

Material: Ck45 DIN 1.1191
Teeth: pressure angle $\alpha=20^\circ$
precision cut
Quality: 8e25 DIN 3962/63/67

Modul (mm)	Zähnezahl No. de dents No. of teeth			D_0	D_k	N	Part No.	Md (Nm)
	Z	BH7						
8.0	15	30	120	136	100	SN 8015	123.7	
	18	30	144	160	110	SN 8018	179.2	
	20	40	160	176	120	SN 8020	225.3	
	24	40	192	208	120	SN 8024	331.3	
	30	40	240	256	160	● SN 8030	525.6	
	36	50	288	304	160	● SN 8036	761.1	
	40	50	320	336	180	● SN 8040	942.6	

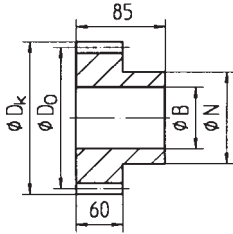

Typ SN

- Auf Anfrage
- Sur demande
- On request

① mit / avec / with $S_f = 1,4$

(Sicherheitsfaktor für Zahnfußbeanspruchung)
(Coefficient de sécurité pour la contrainte de flexion)
(Safety factor for tooth root stress)

① mit / avec / with $S_H = 1,0$

(Sicherheitsfaktor für Zahnflankenbeanspruchung)
(Coefficient de sécurité pour la pression superficielle)
(Safety factor for Hertzian stress)



STIRNRÄDER AUS EDELSTAHL

ROUES DENTÉES EN ACIER INOX PINIONS STAINLESS STEEL

feinstverzahnt
taillage de précision
precision cut
Quality
8e25

Gerade verzahnt, feinstverzahnt

Dentures droites, taillage de précision

Straight tooth, precision cut

Material: X10CrNiS189 DIN 1.4305
Zahnung: Eingriffswinkel $\alpha=20^\circ$
feinstverzahnt
Qualität: 8e25 DIN 3962/63/67

Matière: X10CrNiS189 DIN 1.4305
Denture: angle de pression $\alpha=20^\circ$
taillage de précision
Qualité: 8e25 DIN 3962/63/67

Material: X10CrNiS189 DIN 1.4305
Teeth: pressure angle $\alpha=20^\circ$
precision cut
Quality: 8e25 DIN 3962/63/67

Modul (mm)	Part No.	Zähnezahl No. de dents No. of teeth			B _{H7}	D _o	D _k	N	F	H	b	M _d (Nm)
		Z										
1.0	SNE 1012	12	5	12	14	9	16	8	8	8	0.15	
	SNE 1015	15	6	15	17	12	16	8	8	8	0.23	
	SNE 1018	18	8	18	20	15	16	8	8	8	0.36	
	SNE 1020	20	8	20	22	17	16	8	8	8	0.48	
	SNE 1025	25	8	25	27	22	16	8	8	8	0.70	
	SNE 1030	30	8	30	32	25	16	8	8	8	1.0	
	SNE 1035	35	10	35	37	28	16	8	8	8	1.3	
	SNE 1040	40	10	40	42	30	16	8	8	8	1.7	
	SNE 1050	50	10	50	52	35	16	8	8	8	2.7	
	SNE 1060	60	10	60	62	50	16	8	8	8	3.6	
1.5	SNE 1512	12	6	18	21	13	24	12	12	12	0.5	
	SNE 1515	15	8	22.5	25.5	18	24	12	12	12	0.9	
	SNE 1518	18	8	27	30	22	24	12	12	12	1.3	
	SNE 1520	20	8	30	33	24	24	12	12	12	1.7	
	SNE 1525	25	10	37.5	40.5	30	24	12	12	12	2.6	
	SNE 1530	30	10	45	48	35	24	12	12	12	3.5	
	SNE 1535	35	10	52.5	55.5	40	24	12	12	12	4.6	
	SNE 1540	40	12	60	63	45	24	12	12	12	5.8	
	SNE 1550	50	12	75	78	55	24	12	12	12	9.2	
	SNE 1560	60	15	90	93	60	24	12	12	12	13.1	
2.0	SNE 2012	12	10	24	28	18	30	14	16	16	1.3	
	SNE 2015	15	12	30	34	24	30	14	16	16	2.1	
	SNE 2018	18	12	36	40	30	30	14	16	16	3.2	
	SNE 2020	20	15	40	44	33	30	14	16	16	4.0	
	SNE 2025	25	15	50	54	43	30	14	16	16	6.3	
	SNE 2030	30	15	60	64	50	30	14	16	16	8.6	
	SNE 2035	35	20	70	74	50	30	14	16	16	11.4	
	SNE 2040	40	20	80	84	60	30	14	16	16	14.6	
	SNE 2050	50	20	100	104	80	30	14	16	16	22.2	
	SNE 2512	12	10	30	35	23	37	17	20	20	2.2	
2.5	SNE 2515	15	15	37.5	42.5	30	37	17	20	20	4.0	
	SNE 2518	18	15	45	50	35	37	17	20	20	6.2	
	SNE 2520	20	15	50	55	40	37	17	20	20	7.6	
	SNE 2525	25	15	62.5	67.5	55	37	17	20	20	11.7	
	SNE 2530	30	15	75	80	65	37	17	20	20	16.5	
	SNE 2535	35	20	87.5	92.5	70	37	17	20	20	22.8	
	SNE 2540	40	20	100	105	80	37	17	20	20	28.7	
	SNE 2550	50	20	125	130	100	37	17	20	20	44.8	
	SNE 3012	12	15	36	42	25	43	19	24	24	4.9	
	3.0	SNE 3015	15	15	45	51	35	43	19	24	24	7.3
SNE 3018		18	15	54	60	45	43	19	24	24	11.1	
SNE 3020		20	15	60	66	45	43	19	24	24	13.3	
SNE 3025		25	15	75	81	60	43	19	24	24	20.4	
SNE 3030		30	20	90	96	75	43	19	24	24	30.1	
SNE 3040		40	20	120	126	100	43	19	24	24	52.4	
4.0	SNE 4012	12	20	48	56	35	55	25	32	32	12.2	
	SNE 4015	15	20	60	68	45	55	23	32	32	16.8	
	SNE 4018	18	20	72	80	55	55	23	32	32	24.6	
	SNE 4020	20	20	80	88	65	55	23	32	32	30.2	
	SNE 4025	25	20	100	108	75	55	23	32	32	46.2	
	SNE 4030	30	20	120	128	80	55	23	32	32	65.8	
	SNE 4040	40	20	160	168	100	55	23	32	32	115.4	

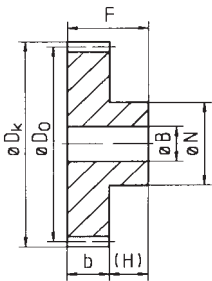

STIRNRÄDER GEHÄRTET

ROUES DENTÉES TREMPÉES PINIONS HARDENED

gehärtet trempée hardened
Quality 9e25

Gerade verzahnt, gehärtet

Material: C 45 DIN 1.1191
gehärtet
Zahnung: Eingriffswinkel $\alpha=20^\circ$
gerade verzahnt
gehärtet
Qualität: 9e25 DIN 3962/63/67

Dentures droites, trempés

Matière: C 45 DIN 1.1191
trempée
Denture: angle de pression $\alpha=20^\circ$
denture droite
trempée
Qualité: 9e25 DIN 3962/63/67

Straight tooth, hardened

Material: C 45 DIN 1.1191
hardened
Teeth: pressure angle $\alpha=20^\circ$
straight teeth
hardened
Quality: 9e25 DIN 3962/63/67

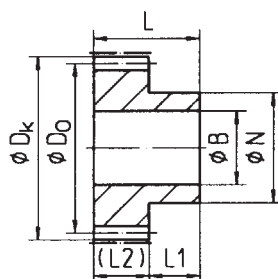

Module (mm)	Part No.	Zähnezahl No de dents No of teeth		Dk	Do	N	L	L1	L2	BH7	m (kg)	Md (Nm)
		Z	Z									
1.0	① 102 020	20	20	22	20	17	25	10	15	8	0.045	3.5
	① 102 024	24	24	26	24	20	25	10	15	8	0.067	4.8
	① 102 030	30	30	32	30	25	25	10	15	8	0.110	7.5
	① 102 040	40	40	42	40	30	25	10	15	10	0.190	12.5
1.5	① 104 020	20	30	33	30	25	30	13	17	8	0.130	8.7
	① 104 024	24	30	39	36	30	30	13	17	8	0.190	13.2
	① 104 030	30	30	48	45	35	30	13	17	10	0.320	19.6
	① 104 040	40	30	63	60	45	30	13	17	12	0.530	26.8
2.0	① 106 020	20	33	44	40	33	35	15	20	15	0.280	18.5
	① 106 024	24	33	52	48	40	35	15	20	15	0.370	31.6
	① 106 030	30	33	64	60	50	35	15	20	15	0.590	46.8
	① 106 040	40	33	84	80	60	35	15	20	20	1.040	58.3
2.5	① 108 020	20	40	55	50	40	40	15	25	15	0.500	38.7
	① 108 024	24	40	65	60	50	40	15	25	15	0.700	48.7
	① 108 030	30	40	80	75	65	40	15	25	15	1.200	76.8
	① 108 040	40	40	105	100	80	40	15	25	20	2.040	143
3.0	① 110 020	20	50	66	60	45	50	20	30	15	0.850	61
	① 110 024	24	50	78	72	55	50	20	30	15	1.250	78
	① 110 030	30	50	96	90	75	50	20	30	20	2.040	138.7
	① 110 040	40	50	126	120	100	50	20	30	20	3.800	225
4.0	① 112 020	20	60	88	80	65	60	20	40	20	1.950	145
	① 112 024	24	60	104	96	75	60	20	40	20	2.800	208
	① 112 030	30	60	128	120	80	60	20	40	20	4.160	333
	① 114 020	20	70	110	100	75	70	20	50	25	3.460	230
5.0	① 114 024	24	70	130	120	80	70	20	50	25	4.800	410
	① 114 030	30	70	160	150	90	70	20	50	25	7.550	690

① Material ETG 100. feinstverzahnt nitriert
Matière ETG 100. taillée à précision. trempé par nitruration
Material ETG 100. precision cut. nitrated



STIRNRÄDER AUS KUNSTSTOFF MIT STAHLNABE

ROUES DENTÉES EN MAT. PLASTIQUE AVEC MOYEU EN ACIER PINIONS IN PLASTIC WITH STEEL HUB

Gerade verzahnt

Mit diesem Programm bieten wir Ihnen einen neuen, qualitativ hochwertigen Konstruktionswerkstoff mit wesentlich mehr Möglichkeiten wie es herkömmliche Kunststoffe bisher geboten haben.

Vor allem aber die Unempfindlichkeit gegen Spannungsrißbildung ist Grundvoraussetzung für den vielfach praktizierten Lauramid-Metallverbund-Guss (Imv). Eine Besonderheit ist hierbei der direkt eingegossene Metallkern in nahezu beliebiger Größe.

Spezielle Sechskant- oder Vielnutprofile am Umfang der Eingussteile und die natürliche Materialschwindung bewirken einen innigen, unlöslichen Werkstoffverbund.

Besondere Bedeutung hat diese Lauramid-spezifische Ausführungsvariante bei hochwertigen Laufrollen- und Zahnradkonstruktionen. Die metallische Nabe bietet dem Konstrukteur den Vorteil passgenauer Lagersitze auch bei höheren Einsatztemperaturen. Darüber hinaus lässt sich mit bewährten, metallüblichen Welle-Nabe-Verbindungen eine optimale Kräfteinleitung erzielen.

Eine oftmals beträchtliche Zeitersparnis in Fertigung und Montage gegenüber einer möglichen Alternativausführung mit verschraubter Metallflanschnabe und Minderaufwand in Konstruktion, Einkauf und Lagerhaltung bewirken zudem einen hohen Rationalisierungseffekt.

Somit ersetzt der Lauramid-Metallverbund in zunehmendem Maße herkömmliche Konstruktionen dieser Art.

Denture droite

Avec ce programme, nous vous offrons un nouveau matériau, de haute valeur qualitative avec bien plus de possibilités que celles offertes jusqu'à présent par les matières synthétiques conventionnelles.

L'insensibilité à la formation de fendillement par contrainte est la condition fondamentale principale d'une utilisation multiple de la fonte composée lauramid-métal (LMV). Une particularité à cet égard est le noyau métallique de pratiquement n'importe quelle grandeur coulé directement.

Les profils hexagonaux ou à utilisations multiples à l'extérieur de la pièce moulée et le retrait naturel du matériau réalisent une liaison des matériaux étroites et insolubles.

Cette variante de réalisation spécifique au lauramid est particulièrement importante pour la construction de galets de roulement et de roues dentées de haute valeur. Le moyeu métallique offre au constructeur l'avantage de la précision du serrage de roulement, même pour des températures d'utilisation élevées. En outre, des assemblages arbre-moyeu métalliques éprouvés réalisent une répartition optimale de la force.

Un effet de rationalisation élevé est obtenu grâce à une économie de temps souvent considérable dans la production et le montage par rapport à une éventuelle solution de rechange avec moyeu métallique à bride vissé, ainsi qu'une réduction des coûts de fabrication, d'achat et de stockage.

C'est pourquoi le composé lauramid-métal remplace de plus en plus les constructions conventionnelles de ce type.

Straight tooth

With this range we offer you a new, high-quality material which incorporates many more capabilities than traditional plastics have been able to provide.

However, it is particularly due to the resistance to stress cracking that lauramid-metal composite casting (Imv) is employed. One special feature is the cast-in metal core, which can be made of almost any size.

Special hexagon or multi-groove profiles around the outside surface of the cast-in core and the natural shrinkage of the material result in a tough composite.

This particular type of lauramid is especially important for high-quality roller and gear designs. The advantage of the metal hub is that it allows for an accurate fitting seal of the bearing even at high operating temperatures. Furthermore, optimum power distribution is achieved by the tried and tested connection between shaft and hub.

Compared to the alternative of a gear assembly with bolted on metal flanges, the composite pinion saves time in manufacturing, assembly and reduces cost for design, purchasing and inventory.

Consequently, lauramid-metal composites is increasingly replacing traditional designs of this type.

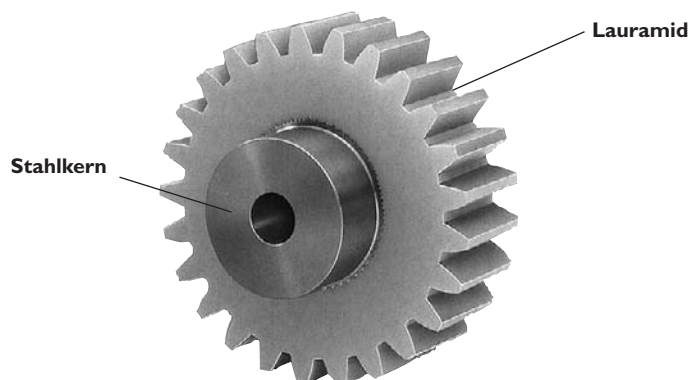

STIRNRÄDER AUS KUNSTSTOFF MIT STAHLNABE

ROUES DENTÉES EN MAT. PLASTIQUE ABEC MOYEU EN ACIER PINION IN PLASTIC WITH STEEL HUB

Werkstoff PA 12 G

Material PA 12 G

Material PA 12 G

Allgemeine Eigenschaften / General features

Eigenschaften	Prüfverfahren	Einheit	Wert
Extraktgehalt (Äthanol)	ISO/R 594/3	Gew.-%	≤ 1
rel. Lösungsviskosität in m-Kresol 0.5% bei 25° C	DIN 53 727	rel.	unlöslich
Rohrdichte bei 23° C	DIN 53 479	g/cm ³	1.025
Schmelzpunkt	Polarisationsmikroskop	° C	181
Wasseraufnahme	DIN 53 472 (50x50x4 mm)	mg	ca. 17
max. Wasseraufnahme bei Normklima 23/65 bei Wasseraufnahme 23° C		Gew.-%	ca. 0.9
		Gew.-%	ca. 1.4

Elektrische Eigenschaften / Electrical properties

Eigenschaften	Prüfverfahren	Einheit	Wert
Prüfkörper 24 Stunden in Normklima 23/50 konditioniert			
Oberflächenwiderstand	DIN 53 482 Verf. ROA	Ω	1013
spez. Durchgangswiderstand bei 23° C	DIN 53 428	Ω cm	2.7 · 1014
bei 70° C		Ω cm	1.0 · 1014
Dielektrizitätszahl (50 Hz) bei 23° C	DIN 53 483	—	3.5
Dielektrischer Verlustfaktor tan δ (50 Hz)	DIN 53 483	—	3.8 · 10 ⁻²
Kriechstromfestigkeit	DIN 53 480 Verf. KB Verf. KC	—	KB 550 KC 600

Mechanische Eigenschaften / Mechanical properties

Eigenschaften	Prüfverfahren	Einheit	Wert
Grenzbiegespannung bei 20° C	DIN 53 452	N/mm ²	90
bei 80° C	Normsab 2	N/mm ²	50
Kugeldruckhärte	DIN 53 456 — H358/10 — H358/60	N/mm ²	103 98
Shore-Härte D	DIN 53 505	—	ca. 75
Shore-Härte A			98–100
Druckspannung	DIN 53 454 bei 0.1% Stauchung	N/mm ²	46
Streckspannung	DIN 53 455	N/mm ²	60
Reissfestigkeit	DIN 53 455	N/mm ²	60
Elastizitätsmodul (Biegung)	DIN 53 457	N/mm ²	2000
Elastizitätsmodul (Zug)	DIN 53 457	N/mm ²	2000
Dehnung bei Streckspannung	DIN 53 455	%	11
bei Bruch		%	10
Kerbschlagzähigkeit (Chapy)			
20° C	DIN 53 453	KJ/m ²	4–20
— 50° C		KJ/m ²	3–15
Abriebfestigkeit	Taber-Abrazer	mg/100U	24

Thermische Eigenschaften / Thermal properties

Eigenschaften	Prüfverfahren	Einheit	Wert
lin. Ausdehnungskoeffizient	VDE 0304 § 4 Teil I		
– 50 – (–30) ° C		10 ⁻⁴ /° C	0.8 – 1.0
+ 30 – (+80) ° C		10 ⁻⁴ /° C	1.0 – 1.8
Anwendungstemperatur max. kurzzeitig		° C	bis 150
Dauertemperaturbeanspruchung (<104 h)	in Öl		140
	in Wasser	° C	90
	in Luft		120
Victat-Erweichungstemperatur Luftfeucht	DIN 53 460	° C	182 – 190
Wärmeformbeständigkeit Luftfeucht	ISO/R 75/B	° C	185 – 190
Spez. Wärme		Kcal/kg ° C	
Wärmeleitfähigkeit	DIN 52 612	Kcal/mh ° C	
Versprödung in Kälte	—	° C	≤ – 50

Gerade verzahnt

Material: Kunststoff PA 12 G
Stahlnabe Ck45 DIN 1.1191
Zahnung: Eingriffswinkel $\alpha=20^\circ$
feinstverzahnt
Qualität: 8e25 DIN 3962/63/67

Denture droite

Matière: Mat. plastique PA 12 G
moyeu en Ck45 DIN 1.1191
Denture: angle de pression $\alpha=20^\circ$
taillage de précision
Qualité: 8e25 DIN 3962/63/67

Straight tooth

Material: Mat. plastic PA 12 G
Hub in Ck45 DIN 1.1191
Teeth: pressure angle $\alpha=20^\circ$
precision cut
Quality: 8e25 DIN 3962/63/67

Modul (mm)

1.5

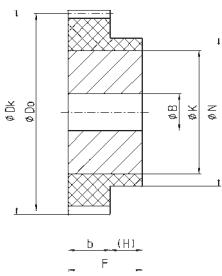

Zähnezahl
No de dents
No of teeth

Z	BH7	N	K	Dk	Do	F	H	b	Part No.	T _N (Nm)
30	10	35	25	48	45	30	13	17	LMV 1530	5.0
36	10	45	35	57	54	30	13	17	LMV 1536	6.2
40	10	50	40	63	60	30	13	17	LMV 1540	6.9
45	10	50	40	70,5	67,5	30	13	17	LMV 1545	7.8
48	10	55	45	75	72	30	13	17	LMV 1548	8.4
50	10	55	45	78	75	30	13	17	LMV 1550	9.0
56	15	65	55	87	84	30	13	17	LMV 1556	10.2
60	15	70	60	93	90	30	13	17	LMV 1560	11.1
64	15	70	60	99	96	30	13	17	LMV 1564	11.8
72	15	80	70	111	108	30	13	17	LMV 1572	13.5
80	20	85	75	123	120	30	13	17	LMV 1580	14.6
90	20	90	80	138	135	30	13	17	LMV 1590	16.4
100	20	110	90	153	150	30	13	17	LMV 15100	19.1
120	20	120	100	183	180	30	13	17	LMV 15120	23.0

T_N (Nm): Übertragbares Drehmoment mit $s_f = 1,4$
Couple admissible avec $s_f = 1,4$
Permissible torque with $s_f = 1,4$

Modul (mm)

2.0

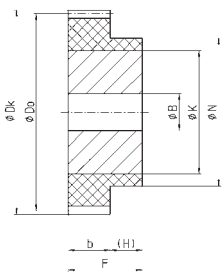

Zähnezahl
No de dents
No of teeth

Z	BH7	N	K	Dk	Do	F	H	b	Part No.	T _N (Nm)
20	10	35	25	44	40	35	15	20	LMV 2020	6.2
25	10	45	35	54	50	35	15	20	LMV 2025	7.8
28	15	45	35	60	56	35	15	20	LMV 2028	8.8
30	15	50	40	64	60	35	15	20	LMV 2030	10.0
36	15	55	45	76	72	35	15	20	LMV 2036	12.7
40	20	65	55	84	80	35	15	20	LMV 2040	14.7
45	20	70	60	94	90	35	15	20	LMV 2045	16.6
48	20	70	60	100	96	35	15	20	LMV 2048	17.8
50	20	75	65	104	100	35	15	20	LMV 2050	18.9
56	20	80	70	116	112	35	15	20	LMV 2056	21.2
60	20	85	75	124	120	35	15	20	LMV 2060	22.9
64	20	90	80	132	128	35	15	20	LMV 2064	24.4
72	25	90	80	148	144	35	15	20	LMV 2072	28.2
80	25	100	90	164	160	35	15	20	LMV 2080	30.1
90	25	110	100	184	180	35	15	20	LMV 2090	34.0
100	25	120	110	204	200	35	15	20	LMV 20100	40.4
120	25	130	120	244	240	35	15	20	LMV 20120	48.7

T_N (Nm): Übertragbares Drehmoment mit $s_f = 1,4$
Couple admissible avec $s_f = 1,4$
Permissible torque with $s_f = 1,4$

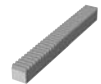

Seite / Page
03.11–03.23
PA 6
03.18

Gerade verzahnt

Material: Kunststoff PA 12 G
Stahlnabe Ck45 DIN 1.1191
Zahnung: Eingriffswinkel $\alpha=20^\circ$
feinstverzahnt
Qualität: 8e25 DIN 3962/63/67

Denture droite

Matière: Mat. plastique PA 12 G
moyeu en Ck45 DIN 1.1191
Denture: angle de pression $\alpha=20^\circ$
taillage de précision
Qualité: 8e25 DIN 3962/63/67

Straight tooth

Material: Mat. plastic PA 12 G
Hub in Ck45 DIN 1.1191
Teeth: pressure angle $\alpha=20^\circ$
precision cut
Quality: 8e25 DIN 3962/63/67

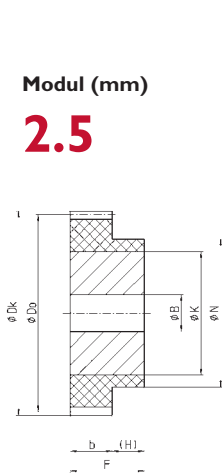

Modul (mm)

2.5

Zähnezahl
No de dents
No of teeth

Z	BH7	N	K	Dk	D0	F	H	b	Part No.	T _N (Nm)
18	10	35	25	50	45	40	15	25	LMV 2518	10.9
20	15	45	35	55	50	40	15	25	LMV 2520	12.1
25	15	50	40	67,5	62,5	40	15	25	LMV 2525	15.3
30	15	55	45	80	75	40	15	25	LMV 2530	20.3
36	15	70	60	95	90	40	15	25	LMV 2536	24.5
40	20	75	65	105	100	40	15	25	LMV 2540	28.7
45	20	80	70	117,5	112,5	40	15	25	LMV 2545	32.2
48	20	85	75	125	120	40	15	25	LMV 2548	34.5
50	20	85	75	130	125	40	15	25	LMV 2550	36.8
60	20	100	90	155	150	40	15	25	LMV 2560	44.3
72	20	110	100	185	180	40	15	25	LMV 2572	54.3
80	20	120	110	205	200	40	15	25	LMV 2580	61.3

Zähnezahl
No de dents
No of teeth

Modul (mm)

3.0

Z	BH7	N	K	Dk	D0	F	H	b	Part No.	T _N (Nm)
18	10	45	35	60	54	50	20	30	LMV 3018	18.7
20	15	45	35	66	60	50	20	30	LMV 3020	20.3
25	15	55	45	81	75	50	20	30	LMV 3025	26.1
30	15	70	60	96	90	50	20	30	LMV 3030	35.3
36	20	80	70	114	108	50	20	30	LMV 3036	42.5
40	20	85	75	126	120	50	20	30	LMV 3040	49.6
45	20	85	75	141	135	50	20	30	LMV 3045	56.0
48	20	90	80	150	144	50	20	30	LMV 3048	53.9
50	20	100	90	156	150	50	20	30	LMV 3050	63.5
60	20	100	90	186	180	50	20	30	LMV 3060	76.4

Zähnezahl
No de dents
No of teeth

Modul (mm)

4.0

Z	BH7	N	K	Dk	D0	F	H	b	Part No.	T _N (Nm)
15	20	50	40	68	60	60	20	40	LMV 4015	36.0
20	20	65	45	88	80	60	20	40	LMV 4020	43.6
25	20	75	65	108	100	60	20	40	LMV 4025	62.2
30	20	85	75	128	120	60	20	40	LMV 4030	83.6
36	30	100	90	152	144	60	20	40	LMV 4036	100.0
40	30	100	90	168	160	60	20	40	LMV 4040	116.0
45	30	110	100	188	180	60	20	40	LMV 4045	131.0
50	30	120	110	208	200	60	20	40	LMV 4050	151.0
60	30	130	120	248	240	60	20	40	LMV 4060	182.0

T_N (Nm): Übertragbares Drehmoment mit $s_F = 1,4$
Couple admissible avec $s_F = 1,4$
Permissible torque with $s_F = 1,4$

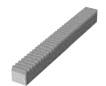

Seite / Page
03.11-03.23
PA 6
03.18

STIRNRÄDER AUS KUNSTSTOFF GESPRITZT

ROUES DENTÉES EN MAT. PLASTIQUE MOULÉE PAR INJECTION PINION IN PLASTIC INJECTION MOULDED

Stirnräder aus Kunststoff gespritzt

Für einfache Antriebe genügen oft unsere aus dem Kunststoff Hostaform C gespritzten Zahnräder, wobei unsere Berechnungsgrundlagen Ihnen einen schnellen Hinweis auf die geeigneten Elemente geben.

Roues cylindriques moulées par injection

Pour des applications inférieures il peut suffire de choisir des pignons faits par injection en Hostaform C ou nos calculs vous aident de choisir très rationnel le pignon correspondant à votre utilisation.

Injection moulded pinions

For inferior applications it might be enough to choose moulded pinions made of Hostaform C where our shown calculation should help to choose the correct elements.



Leistungstabelle

Tableau de chargement

Power transfer

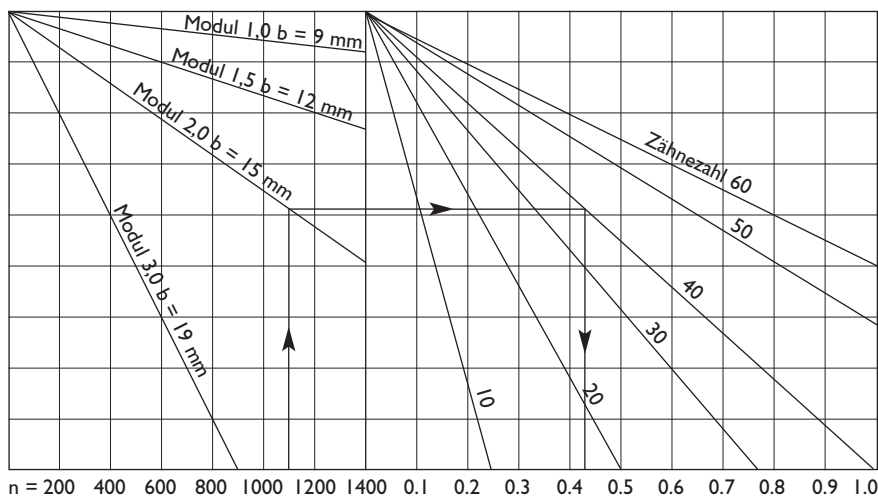

n: Drehzahl
No de tours (min⁻¹)
Revolution

P: Leistung
Puissance (kW)
Power transmissible

Beispiel

Exemple

Example

I. Stirnrad / Roues dentées / Pinions

Modul $m = 2 \text{ mm}$
Zähnezahl $z = 40$
Zahnbreite $b = 15$
Drehzahl $n = 1100 \text{ min}^{-1}$
Übersetzung $i = 1$

Übertragbare Leistung $P = 0.425 \text{ kW}$

STIRNRÄDER AUS KUNSTSTOFF GESPRITZT

ROUES DENTÉES EN MAT. PLASTIQUE MOULÉE PAR INJECTION PINION IN PLASTIC INJECTION MOULDED

Stirnräder aus Kunststoff gespritzt

Material: Kunststoff Hostaform C
Bohrung bearbeitet
Zahnung: Eingriffswinkel $\alpha=20^\circ$
gespritzt
Qualität: 12e28 DIN 3962/63/67

Roues cylindriques moulées par injection

Matière: Mat. plastique Hostaform C
forure travaillée mec.
Denture: angle de pression $\alpha=20^\circ$
moulée par injection
Qualité: 12e28 DIN 3962/63/67

Injection moulded pinions

Material: Mat. plastic Hostaform C
bore mec. made
Teeth: pressure angle $\alpha=20^\circ$
injection moulded
Quality: 12e28 DIN 3962/63/67

Zähnezahl
No de dents
No of teeth

Modul (mm)

0.5

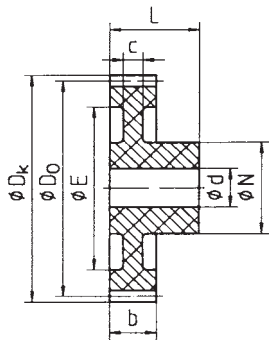

Z	d (H9)	Do	Dk	N	E	L	c	b	Part No.
12	2	6	7	4		7		3	SH 0512
13	2	6.5	7.5	4		7		3	SH 0513
14	2	7	8	5		7		3	SH 0514
15	3	7.5	8.5	6		10		3	SH 0515
16	3	8	9	6		10		3	SH 0516
17	3	8.5	9.5	8		10		3	SH 0517
18	4	9	10	8		10		3	SH 0518
19	4	9.5	10.5	8		10		3	SH 0519
20	4	10	11	8		10		3	SH 0520
21	4	10.5	11.5	8		10		3	SH 0521
22	4	11	12	10		10		3	SH 0522
23	4	11.5	12.5	10		10		3	SH 0523
24	4	12	13	10		10		3	SH 0524
25	4	12.5	13.5	10		10		3	SH 0525
26	4	13	14	10		10		3	SH 0526
27	4	13.5	14.5	10		10		3	SH 0527
28	4	14	15	10		10		3	SH 0528
30	4	15	16	12		10		3	SH 0530
32	4	16	17	12	11	10	2	3	SH 0532
35	4	17.5	18.5	12	12.5	10	2	3	SH 0535
36	4	18	19	12	13	10	2	3	SH 0536
38	4	19	20	12	13.5	10	2	3	SH 0538
40	4	20	21	12	14	10	2	3	SH 0540
42	4	21	22	12	16	10	2	3	SH 0542
45	4	22.5	23.5	12	18.5	10	2	3	SH 0545
48	6	24	25	15	19	10	2	3	SH 0548
50	6	25	26	15	20	10	2	3	SH 0550
52	6	26	27	15	21	10	2	3	SH 0552
54	6	27	28	15	22	10	2	3	SH 0554
55	6	27.5	28.5	15	23	10	2	3	SH 0555
56	6	28	29	15	23	10	2	3	SH 0556
60	6	30	31	15	24	10	2	3	SH 0560
64	6	32	33	15	25	10	2	3	SH 0564
65	6	32.5	33.5	15	27	10	2	3	SH 0565
70	6	35	36	15	29	10	2	3	SH 0570
72	6	36	37	15	30	10	2	3	SH 0572
75	6	37.5	38.5	15	33	10	2	3	SH 0575
80	6	40	41	15	36	10	2	3	SH 0580
90	6	45	46	15	39	10	2	3	SH 0590
96	6	48	49	15	42	10	2	3	SH 0596
100	6	50	51	15	44	10	2	3	SH 05100
120	6	60	61	15	54	10	2	3	SH 05120

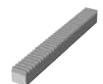

Seite / Page
03.11-03.23
PA 6
03.18

Stirnräder aus Kunststoff gespritzt

Material: Kunststoff Hostaform C
Bohrung bearbeitet
Zahnung: Eingriffswinkel $\alpha=20^\circ$
gespritzt
Qualität: I2e28 DIN 3962/63/67

Roues cylindriques moulées par injection

Matière: Mat. plastique Hostaform C
forure travaillée mec.
Denture: angle de pression $\alpha=20^\circ$
moulée par injection
Qualité: I2e28 DIN 3962/63/67

Injection moulded pinions

Material: Mat. plastic Hostaform C
bore mec. made
Teeth: pressure angle $\alpha=20^\circ$
injection moulded
Quality: I2e28 DIN 3962/63/67

Zähnezahl
No de dents
No of teeth

Modul (mm)

0.7

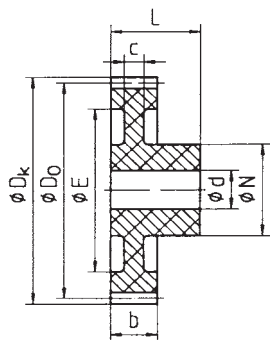

Z	d (H9)	Do	Dk	N	E	L	c	b	Part No.
12	3	8.4	9.8	6		15		6	SH 0712
13	3	9.1	10.5	6		15		6	SH 0713
14	3	9.8	11.2	6		15		6	SH 0714
15	3	10.5	11.9	6		15		6	SH 0715
16	4	11.2	12.6	9		15		6	SH 0716
17	4	11.9	13.3	9		15		6	SH 0717
18	4	12.6	14.0	9		15		6	SH 0718
19	4	13.3	14.7	9		15		6	SH 0719
20	4	14.0	15.4	9		15		6	SH 0720
21	4	14.7	16.1	9		15		6	SH 0721
22	4	15.4	16.8	9		15		6	SH 0722
23	4	16.1	17.5	9		15		6	SH 0723
24	4	16.8	18.2	9	13.5	15	3	6	SH 0724
25	6	17.5	18.9	9	13.5	15	3	6	SH 0725
26	6	18.2	19.6	9	13.5	15	3	6	SH 0726
27	6	18.9	20.3	9	13.5	15	3	6	SH 0727
28	6	19.6	21	9	13.5	15	3	6	SH 0728
30	6	21	22.4	12	16	15	3	6	SH 0730
32	6	22.4	23.8	12	16	15	3	6	SH 0732
35	6	24.5	25.9	15	19	15	3	6	SH 0735
36	6	25.2	26.6	15	19	15	3	6	SH 0736
38	6	26.6	28	15	21.5	15	3	6	SH 0738
40	6	28	29.4	15	21.5	15	3	6	SH 0740
42	6	29.4	30.8	18	24.5	15	2	6	SH 0742
45	6	31.5	32.9	18	24.5	15	2	6	SH 0745
48	8	33.6	35	18	24.5	15	2	6	SH 0748
50	8	35	36.4	18	28	15	2	6	SH 0750
52	8	36.4	37.8	18	28	15	2	6	SH 0752
54	8	37.8	39.2	18	28	15	2	6	SH 0754
55	8	38.5	39.9	18	31	15	2	6	SH 0755
56	8	39.2	40.6	18	31	15	2	6	SH 0756
60	8	42	43.4	18	31	15	2	6	SH 0760
64	8	44.8	46.2	18	37.5	15	2	6	SH 0764
65	8	45.8	46.9	18	37.5	15	2	6	SH 0765
70	8	49	50.4	18	37.5	15	2	6	SH 0770
72	8	50.4	51.8	18	37.5	15	2	6	SH 0772
75	10	52.5	53.9	18	37.5	15	2	6	SH 0775
80	10	56	57.4	21	47	15	2	6	SH 0780
90	10	63	64.4	21	56.5	15	2	6	SH 0790
96	10	67.2	68.6	21	56.6	15	2	6	SH 0796
100	10	70	71.4	21	56.5	15	2	6	SH 07100
120	10	84	85.4	21	77	15	2	6	SH 07120



Seite / Page
03.11-03.23
PA 6
03.18

STIRNRÄDER AUS KUNSTSTOFF GESPRITZT

ROUES DENTÉES EN MAT. PLASTIQUE MOULÉE PAR INJECTION PINION IN PLASTIC INJECTION MOULDED

Stirnräder aus Kunststoff gespritzt

Material: Kunststoff Hostaform C
Bohrung bearbeitet
Zahnung: Eingriffswinkel $\alpha=20^\circ$
gespritzt
Qualität: 12e28 DIN 3962/63/67

Roues cylindriques moulées par injection

Matière: Mat. plastique Hostaform C
forure travaillée mec.
Denture: angle de pression $\alpha=20^\circ$
moulée par injection
Qualité: 12e28 DIN 3962/63/67

Injection moulded pinions

Material: Mat. plastic Hostaform C
bore mec. made
Teeth: pressure angle $\alpha=20^\circ$
injection moulded
Quality: 12e28 DIN 3962/63/67

Zähnezahl
No de dents
No of teeth

Modul (mm)

1.0

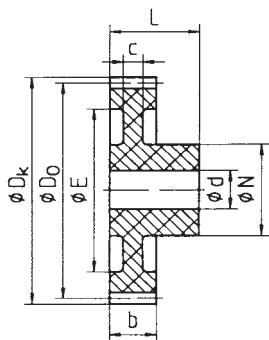

Modul (mm)	Z	d (H9)	Do	Dk	N	E	L	c	b	Part No.
12	4	12	14	9	17				9	SH 1012
13	4	13	15	9	17				9	SH 1013
14	4	14	16	9	17				9	SH 1014
15	4	15	17	9	17				9	SH 1015
16	4	16	18	9	17				9	SH 1016
17	4	17	19	9	17				9	SH 1017
18	4	18	20	9	13.5	17	6	9	9	SH 1018
19	4	19	21	9	13.5	17	6	9	9	SH 1019
20	4	20	22	9	13.5	17	6	9	9	SH 1020
21	5	21	23	12	16	17	6	9	9	SH 1021
22	5	22	24	12	16	17	6	9	9	SH 1022
23	5	23	25	12	16	17	6	9	9	SH 1023
24	6	24	26	15	19	18	6	9	9	SH 1024
25	6	25	27	15	19	18	6	9	9	SH 1025
26	6	26	28	15	19	18	6	9	9	SH 1026
27	6	27	29	15	19	18	6	9	9	SH 1027
28	6	28	30	15	22	18	6	9	9	SH 1028
30	6	30	32	15	22	18	6	9	9	SH 1030
32	6	32	34	18	24.5	18	4.6	9	9	SH 1032
35	8	35	37	18	24.5	18	4.6	9	9	SH 1035
36	8	36	38	18	28	18	4.6	9	9	SH 1036
38	8	38	40	18	28	18	4.6	9	9	SH 1038
40	8	40	42	18	28	18	4.6	9	9	SH 1040
42	8	42	44	18	38	18	4.6	9	9	SH 1042
45	8	45	47	18	37	18	4.6	9	9	SH 1045
48	8	48	50	18	37	18	4.6	9	9	SH 1048
50	8	50	52	18	37	18	4.6	9	9	SH 1050
52	8	52	54	21	47	18	4.6	9	9	SH 1052
54	8	54	56	21	47	18	4.6	9	9	SH 1054
55	8	55	57	21	47	18	4.6	9	9	SH 1055
56	8	56	58	21	47	18	4.6	9	9	SH 1056
60	8	60	62	21	47	18	4.6	9	9	SH 1060
64	10	64	66	21	57	18	4.6	9	9	SH 1064
65	10	65	67	21	57	18	4.6	9	9	SH 1065
70	10	70	72	21	57	18	4.6	9	9	SH 1070
72	10	72	74	21	67	18	4.6	9	9	SH 1072
75	10	75	77	21	67	18	4.6	9	9	SH 1075
80	10	80	82	21	67	18	4.6	9	9	SH 1080
85	10	85	87	21	77	18	4.6	9	9	SH 1085
90	10	90	92	21	77	18	4.6	9	9	SH 1090



Seite / Page
03.11-03.23
PA 6
03.18

Stirnräder aus Kunststoff gespritzt

Material: Kunststoff Hostaform C
Bohrung bearbeitet
Zahnung: Eingriffswinkel $\alpha=20^\circ$
gespritzt
Qualität: I2e28 DIN 3962/63/67

Roues cylindriques moulées par injection

Matière: Mat. plastique Hostaform C
forure travaillée mec.
Denture: angle de pression $\alpha=20^\circ$
moulée par injection
Qualité: I2e28 DIN 3962/63/67

Injection moulded pinions

Material: Mat. plastic Hostaform C
bore mec. made
Teeth: pressure angle $\alpha=20^\circ$
injection moulded
Quality: I2e28 DIN 3962/63/67

Zähnezahl
No de dents
No of teeth

Modul (mm)

I.25

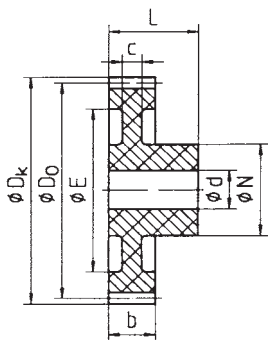

Z	d (H9)	Do	Dk	N	E	L	c	b	Part No.
12	5	15	17.5	9		19		10	SH I2512
13	5	16.25	18.75	9		19		10	SH I2513
14	5	17.5	20	9		19		10	SH I2514
15	5	18.75	21.25	9	13.5	19	7	10	SH I2515
16	5	20	22.5	9	13.5	19	7	10	SH I2516
17	5	21.25	23.75	9	13.5	19	7	10	SH I2517
18	5	22.5	25	12	16	19	7	10	SH I2518
19	5	23.75	26.25	12	16	19	7	10	SH I2519
20	5	25	27.5	12	16	19	7	10	SH I2520
21	6	26.25	28.75	15	19	19	7	10	SH I2521
22	6	27.5	30	15	19	19	7	10	SH I2522
23	6	28.75	31.25	15	19	19	7	10	SH I2523
24	6	30	32.5	15	21.5	19	7	10	SH I2524
25	6	31.25	33.75	15	21.5	19	7	10	SH I2525
26	6	32.5	35	18	24	19	5.5	10	SH I2526
27	6	33.75	36.25	18	24	19	5.5	10	SH I2527
28	8	35	37.5	18	24	19	5.5	10	SH I2528
30	8	37.5	40	18	28	19	5.5	10	SH I2530
32	8	40	42.2	18	28	19	5.5	10	SH I2532
35	8	43.75	46.25	18	28	19	5.5	10	SH I2535
36	8	45	47.5	18	37.5	19	5.5	10	SH I2536
38	8	47.5	50	18	37.5	19	5.5	10	SH I2538
40	8	50	52.5	18	37.5	19	5.5	10	SH I2540
42	8	52.5	55	18	37.5	19	5.5	10	SH I2542
45	8	56.25	58.75	21	47.5	19	5.5	10	SH I2545
48	8	60	62.5	21	47.5	19	5.5	10	SH I2548
50	8	62.5	65	21	47.5	19	5.5	10	SH I2550
52	10	65	67.5	21	57	19	5.5	10	SH I2552
54	10	67.5	70	21	57	19	5.5	10	SH I2554
55	10	68.75	71.25	21	57	19	5.5	10	SH I2555
56	10	70	72.5	21	57	19	5.5	10	SH I2556
60	10	75	77.5	21	67	19	5.5	10	SH I2560
64	10	80	82.5	21	67	19	5.5	10	SH I2564
65	10	81.25	83.75	21	67	19	5.5	10	SH I2565
70	10	87.5	90	21	77	19	5.5	10	SH I2570
75	10	93.75	96.25	21	77	19	5.5	10	SH I2575



Seite / Page
03.11-03.23
PA 6
03.18

STIRNRÄDER AUS KUNSTSTOFF GESPRITZT

ROUES DENTÉES EN MAT. PLASTIQUE MOULÉE PAR INJECTION PINION IN PLASTIC INJECTION MOULDED

Stirnräder aus Kunststoff gespritzt

Material: Kunststoff Hostaform C
Bohrung bearbeitet
Zahnung: Eingriffswinkel $\alpha=20^\circ$
gespritzt
Qualität: 12e28 DIN 3962/63/67

Roues cylindriques moulées par injection

Matière: Mat. plastique Hostaform C
forure travaillée mec.
Denture: angle de pression $\alpha=20^\circ$
moulée par injection
Qualité: 12e28 DIN 3962/63/67

Injection moulded pinions

Material: Mat. plastic Hostaform C
bore mec. made
Teeth: pressure angle $\alpha=20^\circ$
injection moulded
Quality: 12e28 DIN 3962/63/67

Zähnezahl
No de dents
No of teeth

Modul (mm)

1.5

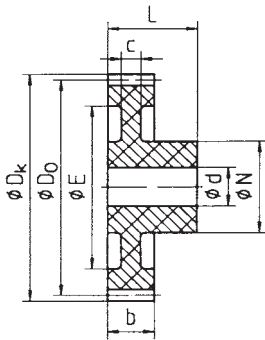

Z	d (H9)	D0	Dk	N	E	L	c	b	Part No.
12	6	18	21	14		23		12	SH 1512
13	6	19.5	22.5	14		23		12	SH 1513
14	6	21	24	14		23		12	SH 1514
15	6	22.5	25.5	14		23		12	SH 1515
16	6	24	27	14		23		12	SH 1516
17	6	25.5	28.5	14		23		12	SH 1517
18	8	27	30	17		23		12	SH 1518
19	8	28.5	31.5	17		23		12	SH 1519
20	8	30	33	17		23		12	SH 1520
21	8	31.5	34.5	17	23	23	5	12	SH 1521
22	8	33	36	17	23	23	5	12	SH 1522
23	8	34.5	37.5	17	23	23	5	12	SH 1523
24	8	36	39	19	27	23	5	12	SH 1524
25	8	37.5	40.5	19	27	23	5	12	SH 1525
26	8	39	42	19	27	23	5	12	SH 1526
27	8	40.5	43.5	19	27	23	5	12	SH 1527
28	8	42	45	19	27	23	5	12	SH 1528
30	10	45	48	24	35	23	5	12	SH 1530
32	10	48	51	24	35	23	5	12	SH 1532
35	10	52.5	55.5	24	43	23	5	12	SH 1535
36	10	54	57	24	43	23	5	12	SH 1536
38	10	57	60	24	43	23	5	12	SH 1538
40	10	60	63	24	50	23	5	12	SH 1540
42	10	63	66	24	50	23	5	12	SH 1542
45	10	67.5	70.5	24	50	23	5	12	SH 1545
48	10	72	75	24	50	23	5	12	SH 1548
50	12	75	78	27	65	23	5	12	SH 1550
52	12	78	81	27	65	23	5	12	SH 1552
54	12	81	84	27	65	23	5	12	SH 1554
55	12	82.5	85.5	27	65	23	5	12	SH 1555
60	12	90	93	27	65	23	5	12	SH 1560

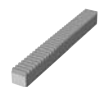

Seite / Page
03.11-03.23
PA 6
03.18

Stirnräder aus Kunststoff gespritzt

Roues cylindriques moulées par injection

Injection moulded pinions

Material: Kunststoff Hostaform C
Bohrung bearbeitet
Zahnung: Eingriffswinkel $\alpha=20^\circ$
gespritzt
Qualität: 12e28 DIN 3962/63/67

Matière: Mat. plastique Hostaform C
forure travaillée mec.
Denture: angle de pression $\alpha=20^\circ$
moulée par injection
Qualité: 12e28 DIN 3962/63/67

Material: Mat. plastic Hostaform C
bore mec. made
Teeth: pressure angle $\alpha=20^\circ$
injection moulded
Quality: 12e28 DIN 3962/63/67

Modul (mm)

2.0

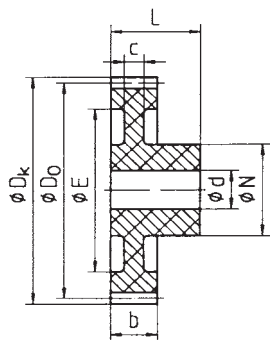

Zähnezahl
No de dents
No of teeth

Z	d (H9)	Do	Dk	N	E	L	c	b	Part No.
12	8	24	28	18.5		27		15	SH 2012
13	8	26	30	18.5		27		15	SH 2013
14	8	28	32	18.5		27		15	SH 2014
15	8	30	34	18.5		27		15	SH 2015
16	8	32	36	17.5	23	27	6	15	SH 2016
17	8	34	38	17.5	25	27	6	15	SH 2017
18	8	36	40	17.5	26	27	6	15	SH 2018
19	8	38	42	17.5	28	27	6	15	SH 2019
20	10	40	44	20	29	27	6	15	SH 2020
21	10	42	46	20	29	27	6	15	SH 2021
22	10	44	48	20	29	27	6	15	SH 2022
23	10	46	50	20	36	27	6	15	SH 2023
24	10	48	52	24	36	27	6	15	SH 2024
25	10	50	54	24	36	27	6	15	SH 2025
26	10	52	56	24	40	27	6	15	SH 2026
27	10	54	58	24	40	27	6	15	SH 2027
28	10	56	60	24	40	27	6	15	SH 2028
30	10	60	64	24	46	27	6	15	SH 2030
32	10	64	68	26	46	27	6	15	SH 2032
35	12	70	74	26	56	27	6	15	SH 2035
36	12	72	76	26	56	27	6	15	SH 2036
38	12	76	80	26	64	27	6	15	SH 2038
40	12	80	84	26	64	27	6	15	SH 2040
42	12	84	88	26	64	27	6	15	SH 2042

Modul (mm)

3.0

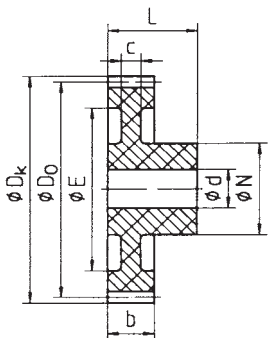

Zähnezahl
No de dents
No of teeth

Z	d (H9)	Do	Dk	N	E	L	c	b	Part No.
12	12	36	42	24		34		19	SH 3012
13	12	39	45	24		34		19	SH 3013
14	12	42	48	24		34		19	SH 3014
15	12	45	51	24	30	34	8	19	SH 3015
16	12	48	54	24	30	34	8	19	SH 3016
17	12	51	57	24	30	34	8	19	SH 3017
18	12	54	60	24	38	34	8	19	SH 3018
19	12	57	63	24	38	34	8	19	SH 3019
20	12	60	66	24	38	34	8	19	SH 3020
21	12	63	69	24	45	34	8	19	SH 3021
22	12	66	72	24	45	34	8	19	SH 3022
23	12	69	75	24	52	34	8	19	SH 3023
24	12	72	78	24	52	34	8	19	SH 3024
25	14	75	81	28	58	34	8	19	SH 3025
26	14	78	84	28	58	34	8	19	SH 3026
27	14	81	87	28	58	34	8	19	SH 3027
28	14	84	90	28	68	34	8	19	SH 3028
30	14	90	96	28	68	34	8	19	SH 3030



Seite / Page
03.11-03.23
PA 6
03.18

SCHNECKEN UND SCHNECKENRÄDER

VIS SANS FIN ET ROUES À VIS SANS FIN WORMS AND WORM GEARS

Wahl des Radsatzes		Selection du vis et de la roue					Selection of worm gear set		
Die Schneckenradsätze werden in 5 Baugrößen und 8 Untersetzungen hergestellt. Die Baugröße ist identisch mit dem Achsabstand.		La gamme des roues à vis sans fin et les vis sans fin est fabriquée suivant 5 tailles avec des rapports de réduction allant de 4.63:1 à 47:1. La taille correspond à l'entraxe.					The range of standard worms and worm gears is available in 5 model sizes and 8 standard ratios. The size is identical to the centreline distance.		
Baugrößen Taille Size	030	045	060	075	090	105	120		
Modul	1.0	1.5	2.0	2.5	3.0	3.5	4.0		
Ratio	4.63:1	5.57:1	6.83:1	8.6:1	11.25:1	15.33:1	23.5:1	47:1	
Gangzahlen No de pas No of starts	8	7	6	5	4	3	2	1	
Die Übersetzung 47:1 ist knapp selbsthemmend. Alle anderen Übersetzungen sind nicht selbsthemmend. Die Einbauvorschriften finden Sie auf Seite 04.35. Für die Achsabstände der Gehäusebohrungen empfehlen wir eine Toleranz von +/- 0.02 mm.		La réduction 47:1 est auto-bloquante. Toutes les autres réductions n'y sont pas. Nous recommandons une tolérance de +/- 0.02 mm pour les entreaxes des longements.					The ratio 47:1 is self locking. All other ratios are not. We suggest a tolerance of +/- 0.02 mm on the centerline of the bores of the housing.		
Richtlinien für die Wahl des Radsatzes Die in der Tabelle aufgeführten Abtriebsmomente T_{2N} (Nm) sind gültig für den Einsatz im stoßfreien Betrieb bei 20° C Umgebungstemperatur. Bei höheren Belastungen sind die Tabellenwerte mit den nachstehenden Faktoren zu korrigieren.		Sélection du vis et de la roue à vis sans fin Les couples indiqués dans le tableau, T_{2N} (Nm), sont valables pour des applications sans chocs et à 20°C de température ambiante. Pour d'autres conditions les valeurs sont à corriger avec les coefficients selon tableaux.					Selection of worm and worm gear The nominal torque T_{2N} (Nm) is valid for applications that run under normal shock free operations and at an ambient temperature of 20°C. Other conditions have to be corrected by factors shown below.		
Zusätzlich zu den erwähnten Betriebsfaktoren ist ein Sicherheitsfaktor einzurechnen, der Ihren Erfahrungen und den anwendungsspezifischen Sicherheitsanforderungen entspricht. Baugrößen 090, 120 und 180: Bei Eintriebs-Drehzahlen über 1500 min ⁻¹ und gleichzeitiger Einschaltdauer über 70%, bitten wir Sie mit Güdel Kontakt aufzunehmen. Hinweise für die Schmierung Seite 04.35.		Pour toutes applications particulières il est nécessaire de mettre un coefficient de sécurité supplémentaire aux coefficients déjà défini dans le tableau, celui-ci correspondant à chacune des applications client. Tailles 090, 120 et 180: En cas de vitesse de rotation à l'entrée supérieure à 1500 min ⁻¹ et un cycle de fonctionnement supérieur à 70% veuillez contacter Güdel s.v.p. Les informations pour la lubrification se trouvent à la page 04.35.					For specific applications it may be necessary to consider a safety factor, in addition to the factors already mentioned in the catalogue. This factor must be based on the customer's experience and any regulations specific to the application. Sizes 090, 120 and 180: In the case of an input speed higher than 1500 min ⁻¹ with a duty cycle higher than 70%, please contact Güdel. The information for the lubrication see page 04.35.		
$T_{2N} \text{ Mech.} \geq T_2 \cdot f_b \cdot f_A$		$T_{2N} \text{ Mech.} \geq T_2 \cdot f_t \cdot f_{ED}$			Beide Gleichungen müssen erfüllt sein / both required / les deux équation doit remplir la condition				
Betriebsfaktor / Coefficient de marche / Service coefficient									
Antrieb	Polynomia	Standard Servo / Sinus ²		FU/VFD	AC-Motor		External Output-shock		
f_b	1.0	1.1		1.25	1.4		1.6		
Anlauffaktor / Coefficient de démarrage / Starting factor									
Anlaufhäufigkeit / Fréquence de démarrage / Starting frequency				≤60/h	≤360/h	≤1200/h	≤3600/h		
f_A				1.0	1.1	1.2	1.3		
Temperaturfaktor / Coefficient de température / Temperature factor									
Umgebungstemperatur / Température ambiante / Ambient temperature				≤10° C	≤20° C	≤30° C	≤40° C	≤50° C	
f_t				0.85	1.0	1.2	1.5	1.9	
Einschaltdauerfaktor / Coefficient de service / Duty factor									
Einschaltdauer / Cycle de service / Duty cycle				≤25%	≤40%	≤60%	≤70%	≤100%	
f_{ED}				0.7	0.9	1.1	1.2	1.4	

T_2 (Nm): Drehmoment der Maschine / Couple de la machine / Required torque for driven machine

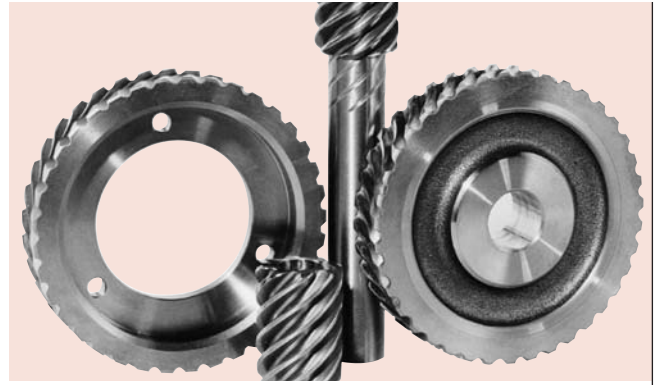

Leistungstabellen

Tableaux des caractéristiques

Selection tables

Typ	i	T _{2max}	n ₁ (min ⁻¹)																			
			6000			4500			3000			1500			1000			500				
			P ₁	T _{2N}	η	P ₁	T _{2N}	η	P ₁	T _{2N}	η	P ₁	T _{2N}	η	P ₁	T _{2N}	η	P ₁	T _{2N}	η		
030	4.63	20	1.16	6.57	0.77	0.99	7.64	0.78	0.76	9.12	0.81	0.46	11.33	0.83	0.34	12.33	0.83	0.19	13.51	0.82		
			0.95	6.37	0.76	0.81	7.37	0.77	0.63	8.74	0.79	0.37	10.74	0.81	0.27	11.63	0.81	0.15	12.67	0.80		
			0.82	6.54	0.73	0.70	7.53	0.74	0.54	8.88	0.76	0.32	10.82	0.79	0.23	11.68	0.79	0.12	12.67	0.78		
			0.73	6.86	0.69	0.62	7.88	0.70	0.47	9.25	0.72	0.27	11.21	0.76	0.19	12.06	0.76	0.11	13.05	0.75		
			0.61	7.23	0.66	0.52	8.28	0.67	0.39	9.69	0.69	0.23	11.68	0.71	0.16	12.55	0.72	0.09	13.54	0.71		
			0.50	7.33	0.60	0.41	8.39	0.63	0.31	9.80	0.65	0.18	11.77	0.66	0.13	12.62	0.66	0.07	13.60	0.64		
			0.42	7.46	0.48	0.33	8.52	0.52	0.25	9.94	0.54	0.14	11.91	0.55	0.10	12.76	0.56	0.06	13.74	0.55		
			0.27	7.51	0.37	0.20	8.57	0.42	0.15	9.99	0.44	0.09	11.96	0.45	0.06	12.80	0.46	0.03	13.77	0.45		
045	4.63	80	3.64	22.5	0.84	3.20	26.9	0.86	2.61	33.5	0.87	1.71	44.3	0.88	1.28	49.7	0.88	0.74	56.6	0.86		
			3.02	22.0	0.82	2.64	26.2	0.84	2.13	32.3	0.86	1.37	42.3	0.87	1.02	47.1	0.87	0.59	53.2	0.85		
			2.61	22.7	0.80	2.26	26.9	0.82	1.81	33.0	0.84	1.15	42.8	0.85	0.85	47.5	0.85	0.49	53.3	0.83		
			2.27	23.9	0.77	1.95	28.3	0.79	1.55	34.6	0.82	0.98	44.5	0.83	0.72	49.2	0.83	0.41	55.0	0.81		
			1.91	25.3	0.74	1.65	29.8	0.76	1.30	36.3	0.78	0.81	46.5	0.80	0.60	51.2	0.79	0.34	57.1	0.77		
			1.57	25.7	0.67	1.31	30.3	0.71	1.03	36.8	0.73	0.64	46.9	0.75	0.47	51.6	0.75	0.27	57.4	0.72		
			1.19	26.2	0.59	0.98	30.8	0.63	0.77	37.4	0.65	0.48	47.5	0.66	0.35	52.3	0.66	0.20	58.0	0.64		
			0.77	26.4	0.46	0.62	31.0	0.50	0.48	37.6	0.52	0.30	47.7	0.53	0.22	52.5	0.53	0.13	58.2	0.50		
060	4.63	200	7.88	50	0.87	7.11	62	0.88	6.00	79	0.89	4.15	109	0.90	3.19	126	0.89	1.90	148	0.88		
			6.52	50	0.86	5.84	60	0.87	4.89	76	0.88	3.33	105	0.89	2.54	120	0.89	1.50	139	0.87		
			5.62	51	0.84	5.00	62	0.86	4.15	78	0.87	2.80	107	0.88	2.12	121	0.87	1.25	140	0.86		
			4.85	54	0.82	4.30	65	0.83	3.54	82	0.85	2.36	111	0.86	1.79	126	0.85	1.05	145	0.84		
			4.10	57	0.78	3.61	69	0.80	2.96	87	0.82	1.96	116	0.83	1.48	131	0.82	0.87	150	0.80		
			3.28	59	0.73	2.86	70	0.75	2.33	88	0.77	1.53	118	0.79	1.16	132	0.78	0.68	151	0.76		
			2.49	60	0.64	2.14	72	0.67	1.72	89	0.70	1.12	119	0.71	0.85	134	0.71	0.50	152	0.68		
			1.68	60	0.48	1.39	72	0.52	1.09	90	0.55	0.71	120	0.56	0.53	135	0.56	0.32	153	0.54		
075	4.63	400	12.74	83	0.89	11.68	103	0.90	10.08	134	0.90	7.25	194	0.91	5.68	227	0.91	3.48	275	0.90		
			10.55	82	0.88	9.61	101	0.89	8.23	131	0.90	5.83	186	0.90	4.53	217	0.90	2.75	260	0.89		
			9.08	85	0.86	8.23	104	0.87	6.99	135	0.89	4.90	190	0.89	3.79	220	0.89	2.29	262	0.88		
			7.83	90	0.84	7.06	110	0.85	5.96	142	0.87	4.14	198	0.88	3.19	229	0.87	1.92	271	0.86		
			6.59	96	0.81	5.91	117	0.83	4.96	149	0.84	3.42	208	0.85	2.63	240	0.85	1.58	282	0.83		
			5.23	97	0.76	4.66	119	0.78	3.88	152	0.80	2.66	211	0.81	2.04	242	0.81	1.23	284	0.79		
			3.89	99	0.68	3.43	121	0.71	2.83	155	0.73	1.93	214	0.74	1.48	245	0.74	0.90	287	0.71		
			2.53	100	0.53	2.18	122	0.56	1.79	156	0.58	1.20	215	0.60	0.92	246	0.59	0.56	288	0.58		
090	4.63	800	20.3	182	0.91	17.9	241	0.92	13.3	359	0.92	10.6	429	0.92	6.6	533	0.91	4.0	650	0.90		
			16.7	179	0.90	14.6	236	0.91	10.7	347	0.92	8.5	411	0.91	5.2	505	0.90	3.3	620	0.89		
			14.3	185	0.89	12.4	243	0.90	9.0	354	0.91	7.1	418	0.91	4.4	509	0.89	2.8	600	0.88		
			12.2	196	0.88	10.6	256	0.89	7.6	371	0.89	6.0	435	0.89	3.7	527	0.88	2.4	600	0.87		
			10.2	208	0.85	8.8	271	0.86	6.3	389	0.87	4.9	456	0.87	3.0	549	0.85	2.0	600	0.85		
			8.0	212	0.82	6.8	276	0.83	4.8	395	0.84	3.8	461	0.83	2.3	550	0.82	1.7	600	0.82		
			5.8	216	0.75	4.9	281	0.76	3.5	401	0.77	2.7	467	0.77	1.6	549	0.75	1.4	600	0.75		
			3.6	218	0.60	3.0	283	0.62	2.1	403	0.64	1.7	470	0.63	1.0	551	0.61	0.8	600	0.61		
105	4.63	1300	31.4	285	0.92	28.0	383	0.93	21.4	585	0.93	17.3	710	0.93	11.1	903	0.92	6.6	1120	0.91		
			25.9	281	0.92	23.0	376	0.92	17.3	567	0.93	13.9	683	0.92	8.8	858	0.92	5.2	1070	0.91		
			22.3	293	0.91	19.6	391	0.91	14.6	584	0.92	11.7	699	0.92	7.3	871	0.91	4.5	1030	0.90		
			19.2	314	0.89	16.9	416	0.90	12.4	617	0.91	9.9	736	0.90	6.2	911	0.89	4.0	1030	0.89		
			16.1	336	0.88	14.1	444	0.88	10.3	656	0.89	8.2	779	0.88	5.1	960	0.87	3.5	1030	0.87		
			12.6	344	0.84	10.9	454	0.85	8.0	667	0.86	6.3	791	0.85	4.0	971	0.84	3.0	1030	0.84		
			9.1	353	0.78	7.8	465	0.79	5.7	681	0.80	4.5	806	0.80	2.8	987	0.78	2.5	1030	0.78		
			5.6	356	0.64	4.8	469	0.66	3.4	686	0.67	2.7	812	0.67	1.7	993	0.64	1.4	1030	0.64		
120	4.63	1900	44.6	406	0.93	40.2	553	0.93	31.3	863	0.93	25.7	1061	0.93	16.8	1378	0.93	10.0	1700	0.92		
			36.8	402	0.92	33.0	543	0.93	25.4	837	0.93	20.7	1022	0.93	13.3	1311	0.92	8.5	1630	0.92		
			31.5	418	0.91	28.1	562	0.92	21.4	859	0.92	17.3	1042	0.92	11.1	1326	0.92	7.0	1580	0.92		
			26.9	443	0.90	23.9	594	0.91	18.1	901	0.91	14.6	1089	0.91	9.3	1376	0.90	6.0	1530	0.90		
			22.4	470	0.88	19.8	629	0.89	14.8	949	0.89	11.9	1143	0.89	7.6	1437	0.88	5.0	1480	0.88		
			17.4	480	0.85	15.3	641	0.86	11.4	963	0.86	9.2	1157	0.86	5.8	1443	0.85	4.0	1430	0.85		
			12.4	491	0.79	10.9	654	0.80	8.1	980	0.81	6.5	1175	0.81	4.1	1438	0.79	3.0	1430	0.79		
			7.5	495	0.66	6.5	659	0.68	4.8	987	0.69	3.9	1182	0.68	2.4	1445	0.66	1.8	1430	0.66		

n₁ (min⁻¹) : Eintriebsdrehzahl / Vitesse d'entrée / input speed
 T_{2max} (Nm) : Max. Drehmoment bei Not – Aus / Couple max. en cas d'arrêt d'urgence / Max. torque in case of emergency stop.
 T_{2N} (Nm) : Nennmoment am Abtrieb / Couple de sortie nominale / Nominal output torque
 P₁ (kW) : Eintriebsleistung / Puissance d'entrée / Input power
 η : Wirkungsgrad / Rendement / Efficiency

SCHNECKEN UND SCHNECKENRÄDER

feinstverzahnt taillage de précision precision cut
Quality 8f24

VIS SANS FIN ET ROUES À VIS SANS FIN WORMS AND WORM GEARS

Schneckenradsätze

Material: Rad in CuZn40Al2
Schnecke 42CrMo4 1.7225
Zahnung: Eingriffswinkel $\alpha=20^\circ$
feinstverzahnt
Qualität: 8f24 DIN 3962/63/67

Vis sans fin et roues à vis sans fin

Matière: Roue en CuZn40Al2
Vis en 42CrMo4 1.7225
Denture: angle de pression $\alpha=20^\circ$
taillage de précision
Qualité: 8f24 DIN 3962/63/67

Worms and worm gears

Material: Worm gear in CuZn40Al2
Worm in 42CrMo4 1.7225
Teeth: pressure angle $\alpha=20^\circ$
precision cut
Quality: 8f24 DIN 3962/63/67

a = 30 mm

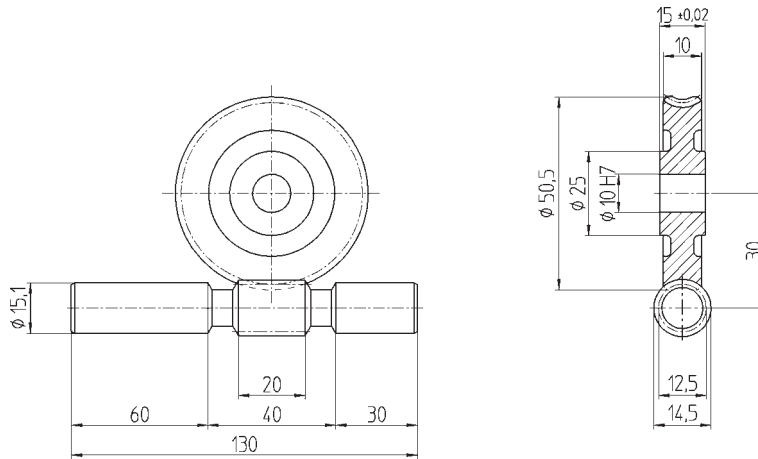

Übersetzung Rapport Ratio i	Modul Module Module	Gangzahl Nombre de pas No of starts	Zähnezahl Nombre de dents No of teeth	Schaftschnecke Vis sans fin Worm shaft Part No.	Schneckenrad Roue à vis sans fin Worm wheel Part No.
47:1	1.0	1	47	S 1001	R 1001
23.5 :1	1.0	2	47	S 1002	R 1002
15.33:1	1.0	3	46	S 1003	R 1003
11.25:1	1.0	4	45	S 1004	R 1004
8.6:1	1.0	5	43	S 1005	R 1005
6.83:1	1.0	6	41	S 1006	R 1006
5.57:1	1.0	7	39	S 1007	R 1007
4.63:1	1.0	8	37	S 1008	R 1008

feinstverzahnt taillage de précision precision cut
Quality 8f24

Schneckenradsätze

Material: Rad in CuZn40Al2
Schnecke ESP 65 / ETG100
Zahnung: Eingriffswinkel $\alpha=20^\circ$
feinstverzahnt
Qualität: 8f24 DIN 3962/63/67

Vis sans fin et roues à vis sans fin

Matière: Roue en CuZn40Al2
Vis en ESP 65 / ETG100
Denture: angle de pression $\alpha=20^\circ$
taillage de précision
Qualité: 8f24 DIN 3962/63/67

Worms and worm gears

Material: Worm gear in CuZn40Al2
Worm in ESP 65
Teeth: pressure angle $\alpha=20^\circ$
precision cut
Quality: 8f24 DIN 3962/63/67

a = 45 mm

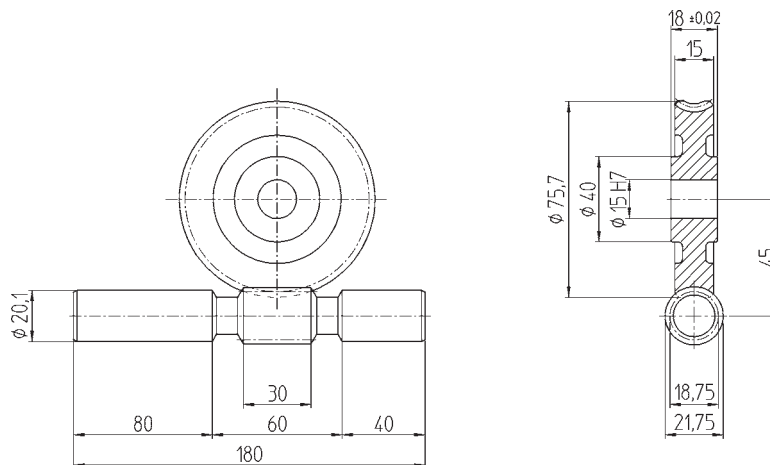

Übersetzung Rapport Ratio i	Modul Module Module	Gangzahl Nombre de pas No of starts	Zähnezahl Nombre de dents No of teeth	Schaftschnecke Vis sans fin Worm shaft Part No.	Schneckenrad Roue à vis sans fin Worm wheel Part No.
47:1	1.5	1	47	S 1501	R 1501
23.5 :1	1.5	2	47	S 1502	R 1502
15.33:1	1.5	3	46	S 1503	R 1503
11.25:1	1.5	4	45	S 1504	R 1504
8.6:1	1.5	5	43	S 1505	R 1505
6.83:1	1.5	6	41	S 1506	R 1506
5.57:1	1.5	7	39	S 1507	R 1507
4.63:1	1.5	8	37	S 1508	R 1508

SCHNECKEN UND SCHNECKENRÄDER

feinstverzahnt taillage de précision precision cut
Quality 8f24

VIS SANS FIN ET ROUES À VIS SANS FIN WORMS AND WORM GEARS

Schneckenradsätze

Material: Rad in G-CuSn12Ni
Stahlnabe in Ck15 DIN 1.1141
Schnecke ESP 65

Zahnung: Eingriffswinkel $\alpha=20^\circ$
feinstverzahnt

Qualität: 8f24 DIN 3962/63/67

Vis sans fin et roues à vis sans fin

Matière: Roue en G-CuSn12Ni
Moyeu en Ck15 DIN 1.1141
Vis en ESP 65

Denture: angle de pression $\alpha=20^\circ$
taillage de précision

Qualité: 8f24 DIN 3962/63/67

Worms and worm gears

Material: Worm gear in G-Cu Sn 12
Hub in St Ck15 DIN 1.1141
Worm in ESP 65

Teeth: 20° pressure angle
precision cut

Quality: 8f24 DIN 3962/63/67

a = 60 mm

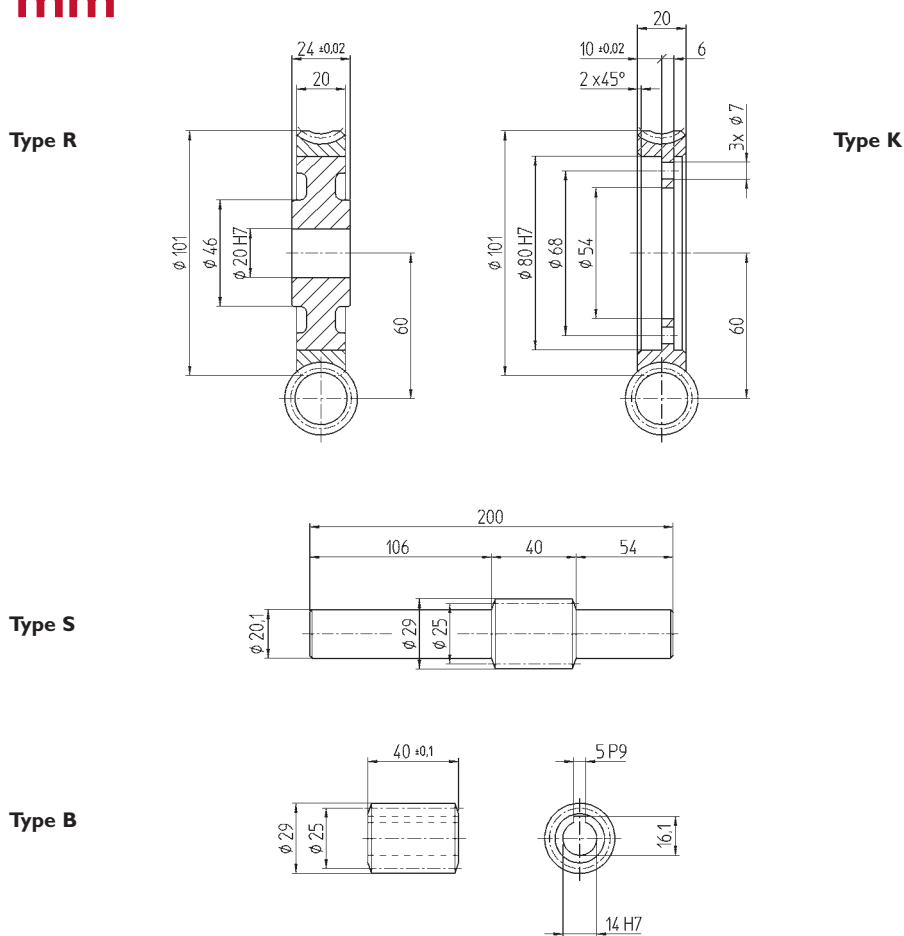

Übersetzung Rapport Ratio i	Modul Module Module	Gangzahl Nombre de pas No of starts	Zähnezahl Nombre de dents No of teeth	Schaftschnecke Vis sans fin Worm shaft Part No.	Bohrungsschnecke Vis sans fin creuse Hollow worm Part No.	Schneckenrad Roue à vis sans fin Worm wheel Part No.	Schneckenradkranz Couronne à vis sans fin Worm wheel ring Part No.
47:1	2	1	47	S 2001	B 2001	R 2001	K 2001
23.5 :1	2	2	47	S 2002	B 2002	R 2002	K 2002
15.33:1	2	3	46	S 2003	B 2003	R 2003	K 2003
11.25:1	2	4	45	S 2004	B 2004	R 2004	K 2004
8.6:1	2	5	43	S 2005	B 2005	R 2005	K 2005
6.83:1	2	6	41	S 2006	B 2006	R 2006	K 2006
5.57:1	2	7	39	S 2007	B 2007	R 2007	K 2007
4.63:1	2	8	37	S 2008	B 2008	R 2008	K 2008

feinstverzahnt
taillage de précision
precision cut
Quality
8f24

Schneckenradsätze

Vis sans fin et roues à vis sans fin

Worms and worm gears

Material: Rad in G-CuSn12Ni
Stahlnabe in Ck15 DIN 1.1141
Schnecke ETG100 DIN 17210
Zahnung: Eingriffswinkel $\alpha=20^\circ$
feinstverzahnt
Qualität: 8f24 DIN 3962/63/67

Matière: Roue en G-CuSn12Ni
Moyeu en Ck15 DIN 1.1141
Vis en ETG100 DIN 17210
Denture: angle de pression $\alpha=20^\circ$
taillage de précision
Qualité: 8f24 DIN 3962/63/67

Material: Worm gear in G-CuSn12Ni
Hub in Ck15 DIN 1.1141
Worm in ETG100 DIN 17210
Teeth: pressure angle $\alpha=20^\circ$
precision cut
Quality: 8f24 DIN 3962/63/67

a = 75 mm

Type R

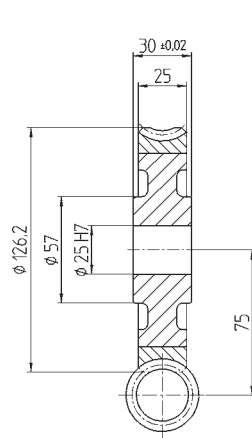

Type K

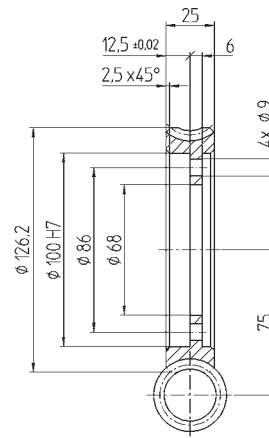

Type S

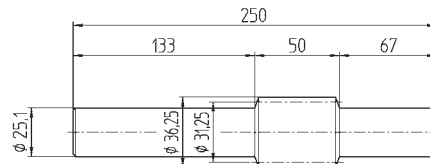

Type B

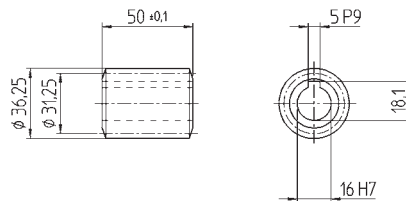

Übersetzung Rapport Ratio i	Modul Module Module	Gangzahl Nombre de pas No of starts	Zähnezahl Nombre de dents No of teeth	Schaftschnecke Vis sans fin Worm shaft Part No.	Bohrungsschnecke Vis sans fin creuse Hollow worm Part No.	Schneckenrad Roue à vis sans fin Worm wheel Part No.	Schneckenradkranz Couronne à vis sans fin Worm wheel ring Part No.
47:1	2.5	1	47	S 2501	B 2501	R 2501	K 2501
23.5 :1	2.5	2	47	S 2502	B 2502	R 2502	K 2502
15.33:1	2.5	3	46	S 2503	B 2503	R 2503	K 2503
11.25:1	2.5	4	45	S 2504	B 2504	R 2504	K 2504
8.6:1	2.5	5	43	S 2505	B 2505	R 2505	K 2505
6.83:1	2.5	6	41	S 2506	B 2506	R 2506	K 2506
5.57:1	2.5	7	39	S 2507	B 2507	R 2507	K 2507
4.63:1	2.5	8	37	S 2508	B 2508	R 2508	K 2508

SCHNECKEN UND SCHNECKENRÄDER

feinstverzahnt taillage de précision precision cut
Quality 8f24

VIS SANS FIN ET ROUES À VIS SANS FIN WORMS AND WORM GEARS

Schneckenradsätze

Material: Rad in G-CuSn12Ni
Stahlnabe in Ck15 DIN 1.1141
Schnecke ESP 65

Zahnung: Eingriffswinkel $\alpha=20^\circ$
feinstverzahnt

Qualität: 8f24 DIN 3962/63/67

Vis sans fin et roues à vis sans fin

Matière: Roue en G-Cu Sn 12
Moyeu en Ck15 DIN 1.1141
Vis en ESP 65

Denture: angle de pression $\alpha=20^\circ$
taillage de précision

Qualité: 8f24 DIN 3962/63/67

Worms and worm gears

Material: Worm gear in G-Cu Sn 12
Hub in Ck15 DIN 1.1141
Worm in ESP 65

Teeth: pressure angle $\alpha=20^\circ$
precision cut

Quality: 8f24 DIN 3962/63/67

a = 90 mm

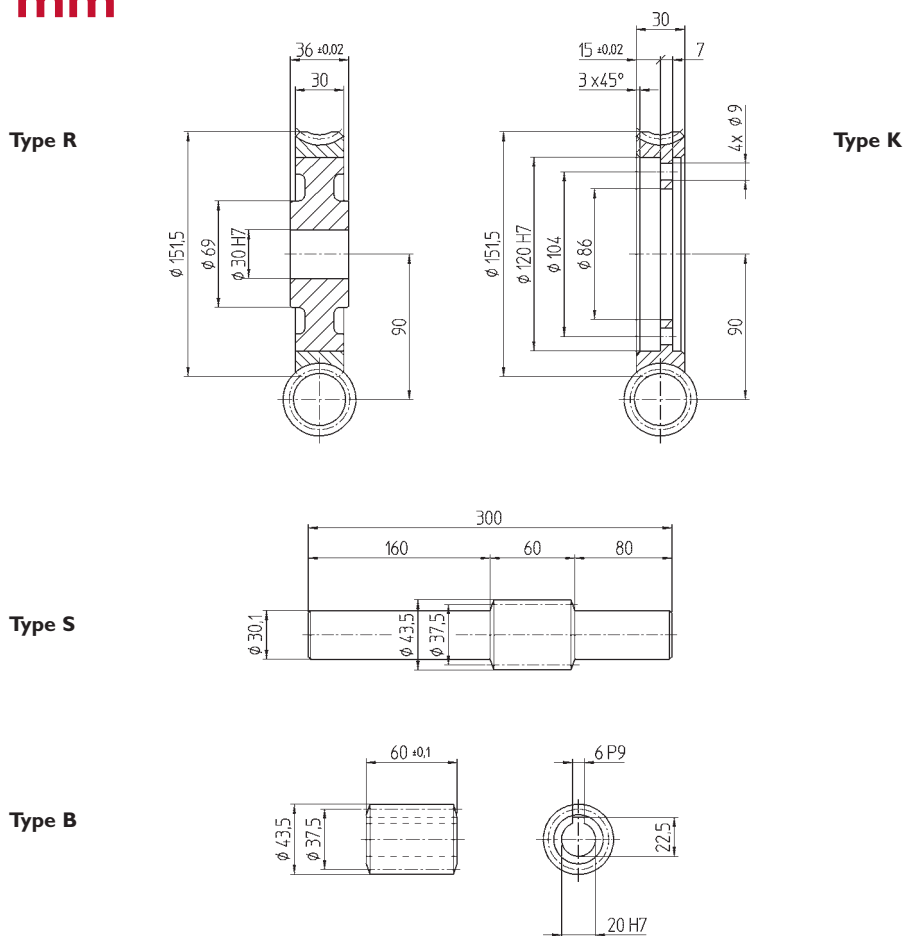

Übersetzung Rapport Ratio i	Modul Module Module	Gangzahl Nombre de pas No of starts	Zähnezahl Nombre de dents No of teeth	Schaftschnecke Vis sans fin Worm shaft Part No.	Bohrungsschnecke Vis sans fin creuse Hollow worm Part No.	Schneckenrad Roue à vis sans fin Worm wheel Part No.	Schneckenradkranz Couronne à vis sans fin Worm wheel ring Part No.
47:1	3.0	1	47	S 3001	B 3001	R 3001	K 3001
23.5 :1	3.0	2	47	S 3002	B 3002	R 3002	K 3002
15.33:1	3.0	3	46	S 3003	B 3003	R 3003	K 3003
11.25:1	3.0	4	45	S 3004	B 3004	R 3004	K 3004
8.6:1	3.0	5	43	S 3005	B 3005	R 3005	K 3005
6.83:1	3.0	6	41	S 3006	B 3006	R 3006	K 3006
5.57:1	3.0	7	39	S 3007	B 3007	R 3007	K 3007
4.63:1	3.0	8	37	S 3008	B 3008	R 3008	K 3008

feinstverzahnt
taillage de précision
precision cut
Quality
8f24

Schneckenradsätze

Vis sans fin et roues à vis sans fin

Worms and worm gears

Material: Rad in G-CuSn12Ni
Stahlnabe in Ck15 DIN 1.1141
Schnecke ESP 65
Zahnung: Eingriffswinkel $\alpha=20^\circ$
feinstverzahnt
Qualität: 8f24 DIN 3962/63/67

Matière: Roue en G-Cu Sn 12
Moyeu en Ck15 DIN 1.1141
Vis en ESP 65
Denture: angle de pression $\alpha=20^\circ$
taillage de précision
Qualité: 8f24 DIN 3962/63/67

Material: Worm gear in G-Cu Sn 12
Hub in Ck15 DIN 1.1141
Worm in ESP 65
Teeth: pressure angle $\alpha=20^\circ$
precision cut
Quality: 8f24 DIN 3962/63/67

a = 105 mm

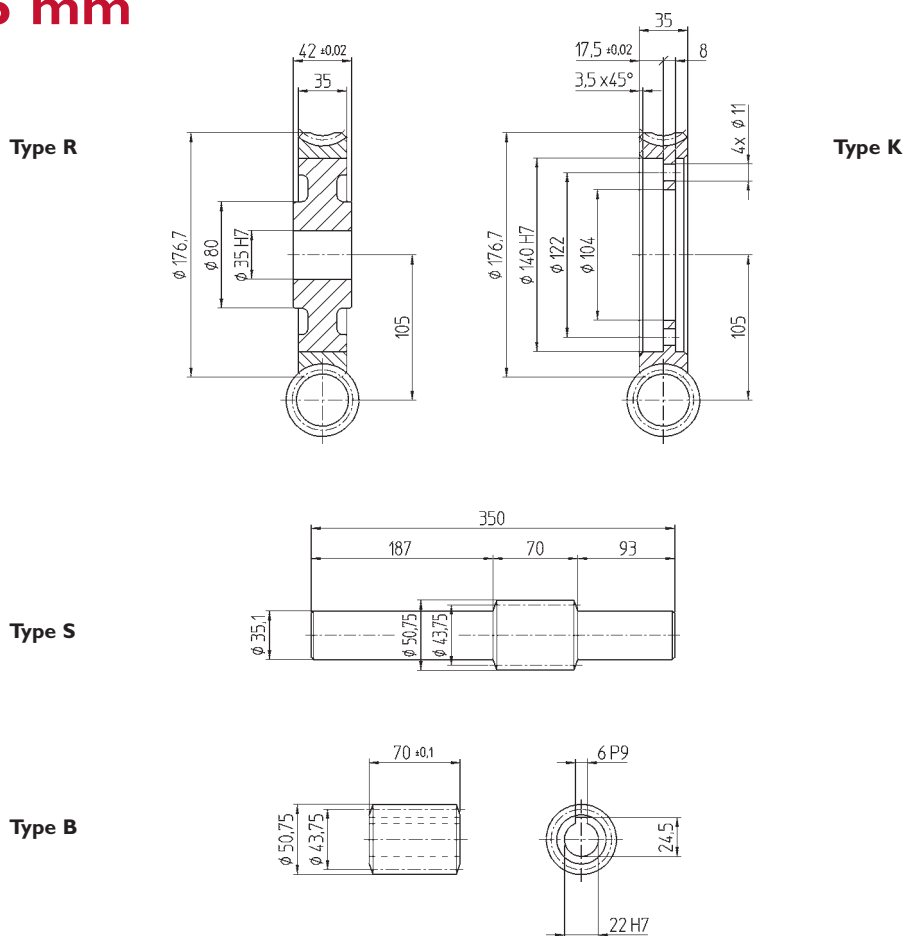

Übersetzung Rapport Ratio i	Modul Module Module	Gangzahl Nombre de pas No of starts	Zähnezahl Nombre de dents No of teeth	Schaftschnecke Vis sans fin Worm shaft Part No.	Bohrungsschnecke Vis sans fin creuse Hollow worm Part No.	Schneckenrad Roue à vis sans fin Worm wheel Part No.	Schneckenradkranz Couronne à vis sans fin Worm wheel ring Part No.
47:1	3.5	1	47	S 3501	B 3501	R 3501	K 3501
23.5 :1	3.5	2	47	S 3502	B 3502	R 3502	K 3502
15.33:1	3.5	3	46	S 3503	B 3503	R 3503	K 3503
11.25:1	3.5	4	45	S 3504	B 3504	R 3504	K 3504
8.6:1	3.5	5	43	S 3505	B 3505	R 3505	K 3505
6.83:1	3.5	6	41	S 3506	B 3506	R 3506	K 3506
5.57:1	3.5	7	39	S 3507	B 3507	R 3507	K 3507
4.63:1	3.5	8	37	S 3508	B 3508	R 3508	K 3508

SCHNECKEN UND SCHNECKENRÄDER

feinstverzahnt taillage de précision precision cut
Quality 8f24

VIS SANS FIN ET ROUES À VIS SANS FIN WORMS AND WORM GEARS

Schneckenradsätze

Material: Rad in G-CuSn12Ni
Stahlnabe in Ck15 DIN 1.1141
Schnecke ESP 65

Zahnung: Eingriffswinkel $\alpha=20^\circ$
feinstverzahnt

Qualität: 8f24 DIN 3962/63/67

Vis sans fin et roues à vis sans fin

Matière: Roue en G-CuSn12Ni
Moyeu en Ck15 DIN 1.1141
Vis en ESP 65

Denture: angle de pression $\alpha=20^\circ$
taillage de précision

Qualité: 8f24 DIN 3962/63/67

Worms and worm gears

Material: Worm gear in G-CuSn12Ni
Hub in Ck15 DIN 1.1141
Worm in ESP 65

Teeth: pressure angle $\alpha=20^\circ$
precision cut

Quality: 8f24 DIN 3962/63/67

a = 120 mm

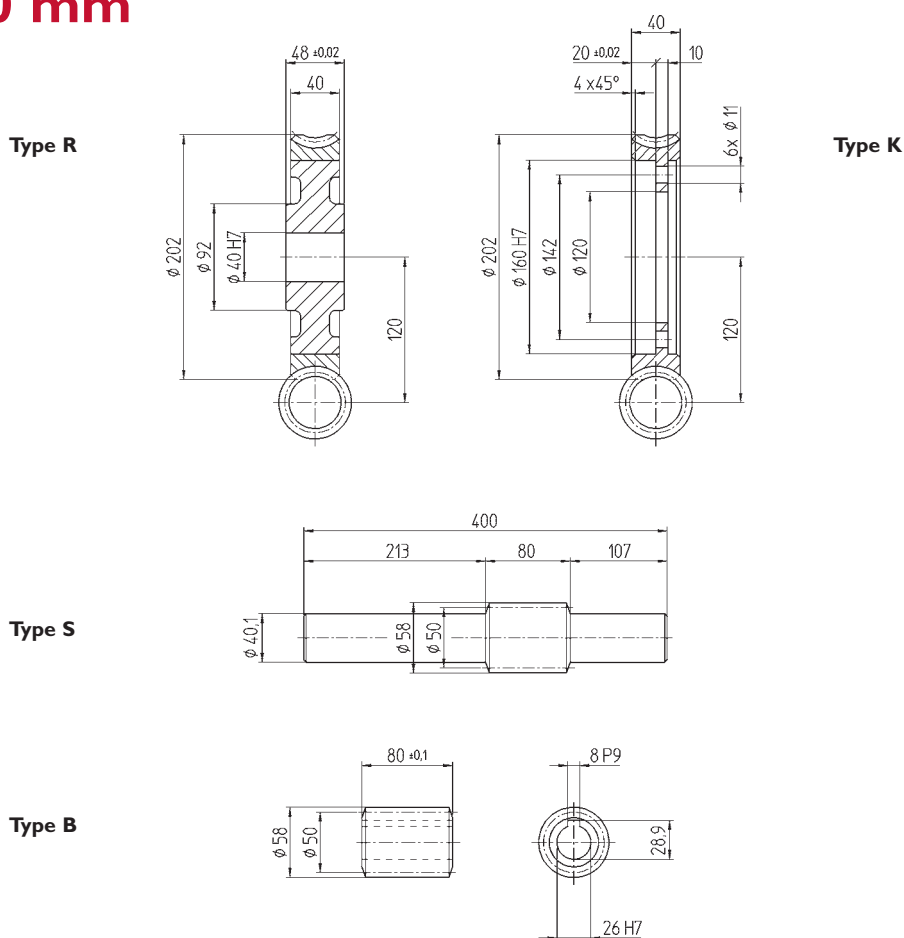

Übersetzung Rapport Ratio i	Modul Module Module	Gangzahl Nombre de pas No of starts	Zähnezahl Nombre de dents No of teeth	Schaftschnecke Vis sans fin Worm shaft Part No.	Bohrungsschnecke Vis sans fin creuse Hollow worm Part No.	Schneckenrad Roue à vis sans fin Worm wheel Part No.	Schneckenradkranz Couronne à vis sans fin Worm wheel ring Part No.
47:1	4	1	47	S 4001	B 4001	R 4001	K 4001
23.5 :1	4	2	47	S 4002	B 4002	R 4002	K 4002
15.33:1	4	3	46	S 4003	B 4003	R 4003	K 4003
11.25:1	4	4	45	S 4004	B 4004	R 4004	K 4004
8.6:1	4	5	43	S 4005	B 4005	R 4005	K 4005
6.83:1	4	6	41	S 4006	B 4006	R 4006	K 4006
5.57:1	4	7	39	S 4007	B 4007	R 4007	K 4007
4.63:1	4	8	37	S 4008	B 4008	R 4008	K 4008

Einbau und Schmierung

Seitliche Lage

Als Bezugsfläche für die seitliche Lagerung gilt für die Räder die tolerierte Nabenstirnfläche **1**. Für die Ringe die Anschlagfläche **2**. Für alle Module sollte die seitliche Verschiebung den Wert von $c \leq \pm 0,02$ nicht überschreiten.

Montage et Lubrification

Positionnement latérale

La surface frontale **1** du moyeu à tolérances définies sert de référence pour le positionnement latéral des roulements par les roues. Pour les couronnes, ce sont les surfaces de référence **2**. Pour tous les modules, le décalage latéral ne devrait pas dépasser la valeur de $\leq \pm 0,02$.

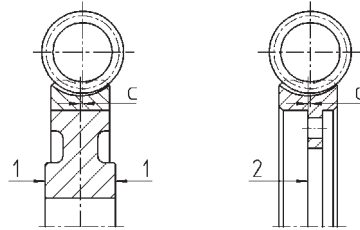

Assembly and Lubrication

Axial position

Référence surface for the mounting of the worm gears are face **1** and **2**. The lateral error should not exceed $\leq \pm 0,02$.

Mit Hilfe von Tuschiefarbe kann das Tragbild ermittelt werden und entsprechende Korrekturen können gemacht werden.

A l'aide de couleur de marquage, la marque de contact peut être visualisée et sert à définir les corrections à faire.

Rad in diese Richtung schieben
Ajuster roue vers la gauche
Shift worm gear in this direction

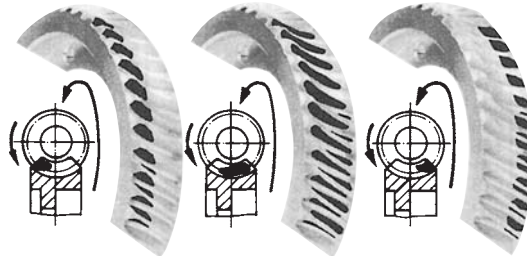

korrekte Markierung
Position correcte
Correct position

Rad in diese Richtung schieben
Ajuster roue vers la gauche
Shift worm gear in this direction



Schmierung

Bei hohen Anlauffrequenzen hängt der Wirkungsgrad und die Lebensdauer in grossem Masse von der verwendeten Ölqualität ab. Es ist von grösster Wichtigkeit nur synthetische Schmiermittel gemäss Tabelle zu verwenden.

Lubrification

Le choix du lubrifiant est très important pour la durée de vie des roues à vis sans fin et les vis. Il ne faut utiliser que des lubrifiants synthétiques suivant tableau.

Lubrification

The efficiency and durability of worm gears with high frequency of starts depends a great deal on the quality of oil used. Of utmost importance is the use of synthetic lubricants as shown in the table below.

Schmierstoff
Lubricant
Lubricant

Mobil

Mobil
Glygoyl HE



Degol
GS 460



BP Energol
SG-XP 460

Texaco

Pinnacle
S 460



Tivela
Oil SD



Klübersynth
GH6-220

GÜDEL

Lieferumfang

Der vorliegende Katalog umfasst die Komponenten der Linear- und Antriebstechnik. Der Inhalt widerspiegelt die Erfahrung von mehr als 5 Jahrzehnten der Entwicklung und Fertigung von Längsführungen, Verzahnungen und Getriebebau.

Das nach ISO 9001: 2000 aufgebaute Qualitätssystem, eine grosse Lagerhaltung und ein weltweites Vertriebsnetz garantieren einen optimalen Kundennutzen. Das umfangreiche Standardprogramm ermöglicht einen schnellen Zugriff auf alle Komponenten.

Ein erfahrenes Ingenieurteam hilft Ihnen bei der Auswahl, erarbeitet mit Ihnen Einbauvorschläge und optimiert Ihren Anwendungsfall. Auch Sonderteile nach Ihren Zeichnungen stellen wir gerne für Sie her. Sprechen Sie mit uns!

Etendue de la livraison

Le catalogue suivant comprend les composants de la technique linéaire et d'entraînement. Le contenu reflète l'expérience de plus de 5 décennies de développement et de fabrication de guides longitudinaux, de dentures et de construction d'engrenages.

Le système de qualité élaboré selon ISO 9001: 2000, un stock important et un réseau de distribution mondial garantissent au client un profit optimal.

La riche gamme standard permet un accès rapide à tous les composants.

Une équipe d'ingénieurs expérimentés vous aidera à choisir, travaillera avec vous des projets de montage et optimisera votre cas d'application. Nous fabriquerons également des pièces spéciales pour vous selon vos dessins. Parlez-nous de vos applications!

Scope of supply

This catalogue covers all the components of the linear and drive technology. Its content reflects the experience of more than 5 decades in the development and manufacture of linear guides, gears and gearboxes.

A quality system based on ISO 9001: 2000, a large inventory and a global distribution network guarantee optimal benefits to the customer. The extensive standard programme makes rapid access to all components possible at all times.

An experienced engineering team will help you in your selection, and assist you in drawing up installation proposals and in the optimisation of your application.

We will also be pleased to manufacture custom components to your own drawings. Call us!

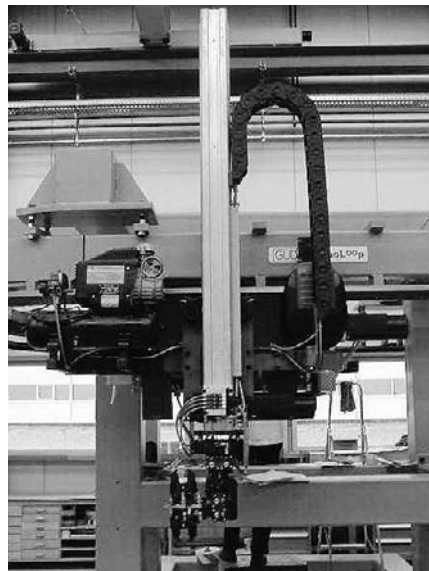
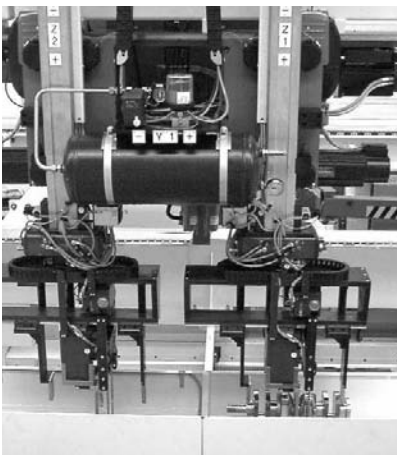



Lieferumfang

Etendue de la livraison

Scope of supply

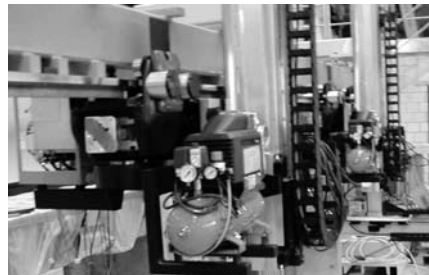
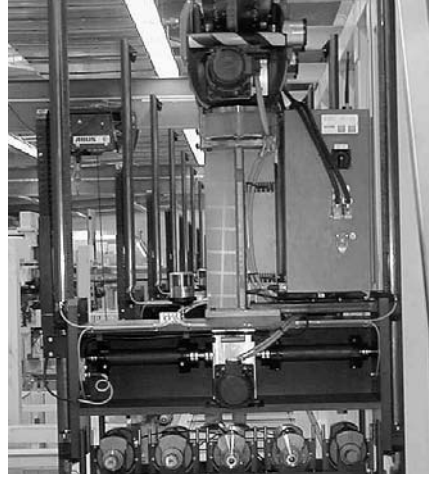

www.gudel.com

Besuchen Sie uns im Internet.
Unsere Web-Site www.gudel.com wurde
völlig neu überarbeitet und bietet Ihnen
folgende Möglichkeiten.

- Interessante Neuentwicklungen
- Produktübersicht
 - Komponenten
 - Module
 - Robotics
 - Systems
- Down-Load Funktionen für
Zeichnungsunterlagen
- Anwendungsbeispiele
- Messdaten

www.gudel.com

Nous vous invitons à vous connecter sur Internet.
à l'adresse www.gudel.com
Notre site a été refait complètement et vous
offre les possibilités suivantes:

- Les nouveautés intéressantes
- Index des catalogues produits
 - composants
 - modules
 - robotics
 - systems
- Chargement des plans de nos produits.
- Applications
- Dates de nos participations aux différents
Salons d'exposition.

www.gudel.com

Visit us on our Homepage www.gudel.com
Our web-site is completely reworked and
offer you following possibilities:

- Interesting news
- Overall view of our catalogues
 - components
 - modules
 - robotics
 - systems
- Downloads of drawings
- Applications
- Dates of our exhibitions



GÜDEL AG

Industrie Nord
CH-4900 Langenthal
Switzerland
phone +41 62 916 91 91
fax +41 62 916 91 50
eMail info@ch.gudel.com
www.gudel.com

GÜDEL GmbH

Carl-Benz-Strasse 5
D-63674 Altenstadt
Germany
phone +49 6047 9639 0
fax +49 6047 9639 90
eMail info@de.gudel.com
www.gudel.com

GÜDEL Inc.

4881 Runway Blvd.
US-Ann Arbor, MI 48108
USA
phone +1 734 214 0000
fax +1 734 214 9000
eMail info@us.gudel.com
www.gudel.com
